

ISA-PLAN® - SMD Präzisionswiderstände / SMD precision resistors

TECHNISCHE DATEN / TECHNICAL DATA		
Widerstandswerte	Resistance values	5 mOhm - 2 Ohm
Toleranz	Tolerance	0.5 %, 1 %, 2 %, 5 %
Temperaturkoeffizient	Temperature coefficient (tcr)	< 20 ppm/K
Temperaturbereich	Applicable temperature range	-55 °C to +170 °C
Belastbarkeit	Load capacity	3 W
Innerer Wärmewiderstand (R_{thi})	Internal heat resistance (R_{thi})	< 20 K/W
Isolationsspannung	Dielectric withstanding voltage	200 V
Induktivität	Inductance	< 3 nH
Stabilität (Nennlast) Abweichung T_K = Kontaktstellentemperatur Stability (nominal load) deviation T_K = Terminal temperature		< 0.5 % nach/after 2000 h (T_K = 70 °C) < 0.7 % nach/after 2000 h (T_K = 110 °C)

MERKMALE / FEATURES

- 3 Watt Dauerleistung bei 70 °C
- 3 Watt permanent power at 70 °C
- Dauerströme bis 25 A (5 mOhm)
- Constant current up to 25 Amps (5 mOhm)
- Kleine Baugröße (2512)
- Small size (2512)
- Sehr hohe Pulsbelastbarkeit
- High pulse power rating
- Sehr gute Langzeitstabilität
- Excellent long term stability
- Bauteilemontage: Reflow-, und IR-Löten
- Mounting: reflow-, and infrared soldering

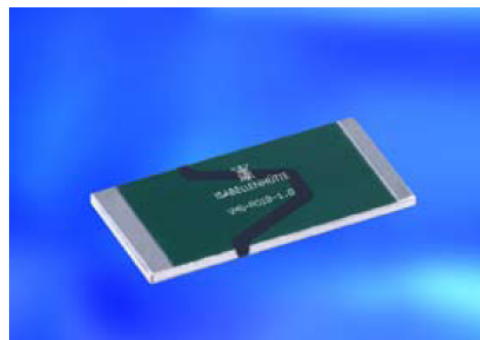

Bauform/Size 2512

APPLIKATIONEN / APPLICATION

- Messwiderstand für Leistungshybride
- Current sensor for power hybrid applications
- Steuergeräte in der Automobiltechnik
- Control systems for the automotive market
- Leistungsmodule
- Power modules
- Frequenzumrichter
- frequency converters
- Schaltnetzteile
- Switch mode power supplies

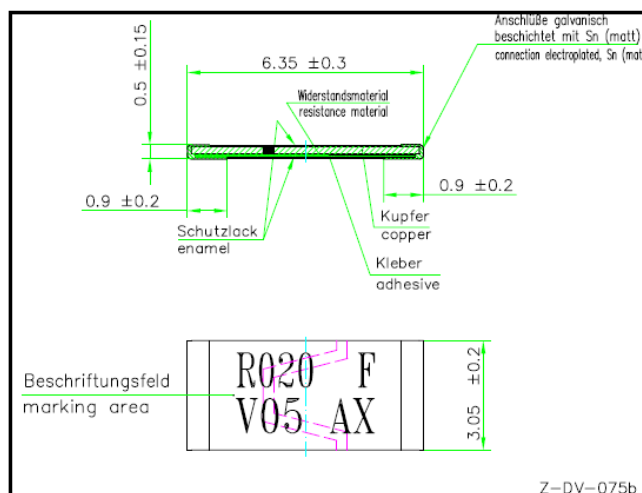



TK, Lastminderung und Langzeitstabilität / TCR, power derating and long term stability

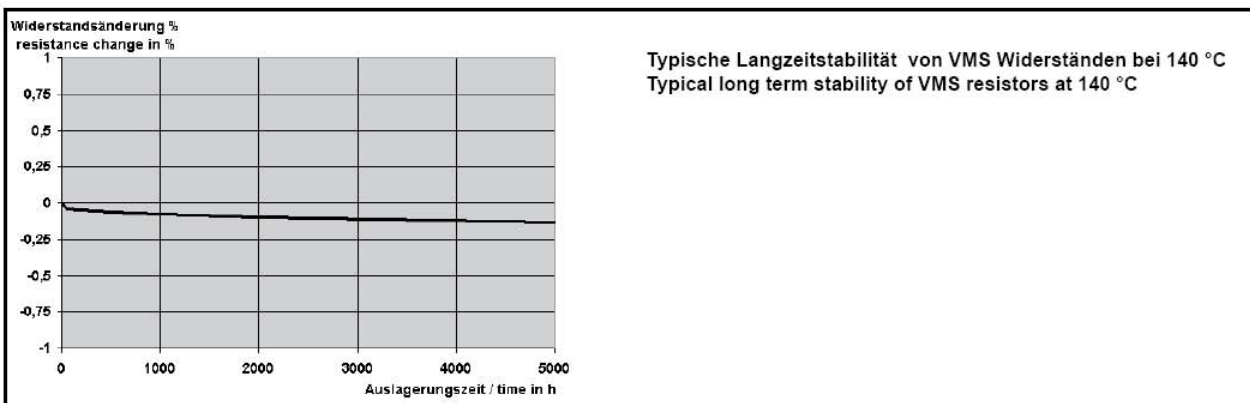
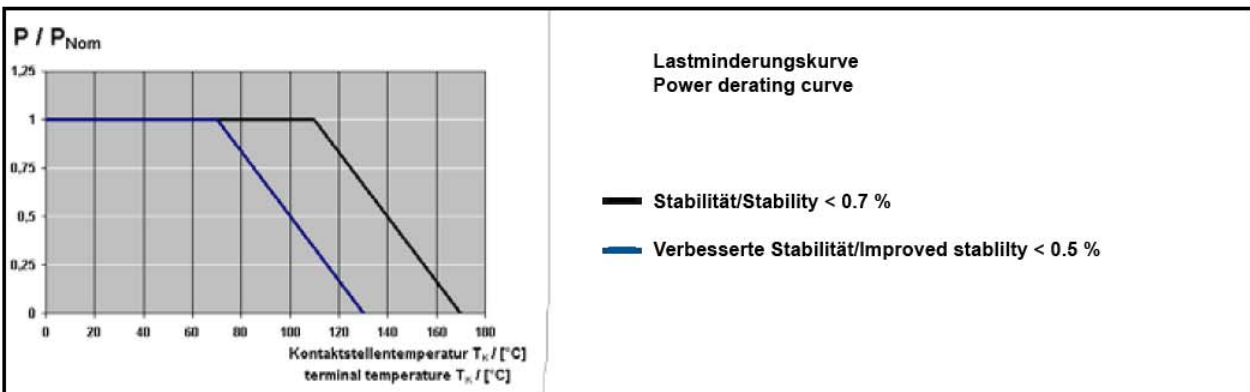
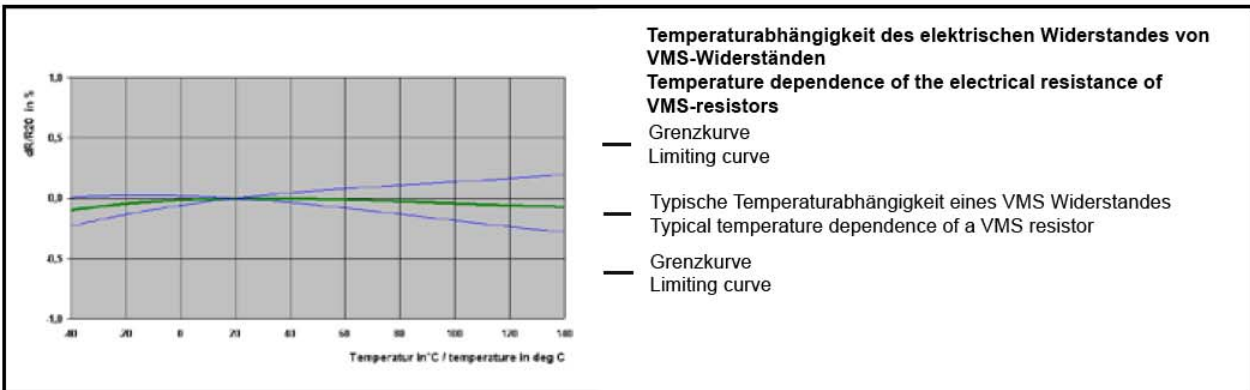

Vorschlag für Leiterplatten Layout (Reflowlöten)
Proposal for pcb-layout (reflow soldering)

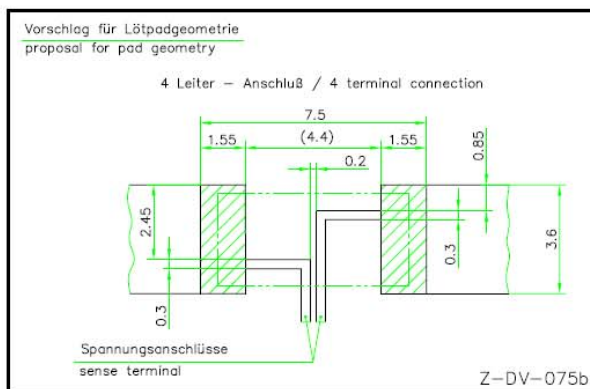

Lötprofil Vorschlag / Recommended solder profile			
Reflow-, IR-löten			
Reflow, infrared soldering			
Temperatur	260 °C	255 °C	217 °C
Zeit (s)	peak	40	90
<p>RoHS 2002/95/EG konform seit Produktstart. Ausführliche Informationen erhalten Sie auf unserer Homepage: www.isabellenhuette.de</p> <p>RoHS 2002/95/EC compliance since product launch. For more information please visit our website: www.isabellenhuette.de</p>			

GURTINFORMATIONEN TAPE & REEL INFORMATION	
Norm / Specification	DIN EN 60286-3
Anzahl Bauteile/Parts per reel	7000*
* Änderungen vorbehalten/rights to amend data is reserved	

BESTELLBEZEICHNUNG / ORDERING CODE		
VMS-R010-1.0		
Typ	Widerstandswert	Toleranz
Type	Resistance value	Tolerance
VMS	10 mOhm	1.0 %

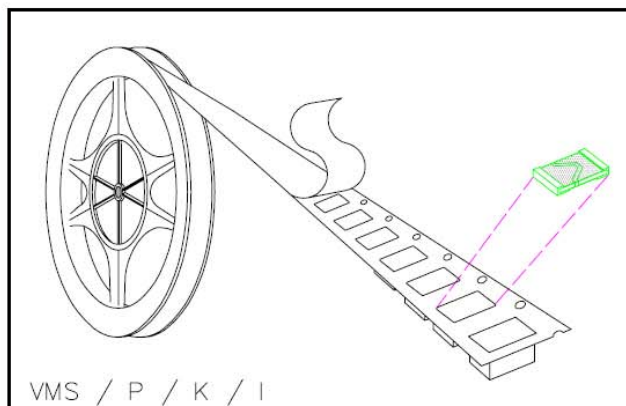

Gewährleistung

Alle Angaben über Eignung, Verarbeitung und Anwendung unserer Produkte, technische Beratung und sonstige Angaben erfolgen nach bestem Wissen, befreien den Käufer jedoch nicht von eigenen Prüfungen und Versuchen.

Warranty

All information regarding the suitable, workability and applicability of our products, all technical advice and other information are provided to the best of our knowledge and belief, but shall not discharge the buyer from his own examinations and tests.



Grenzkurve für maximale Pulsenergie bzw. Pulsleistung für Dauerbetrieb
Maximum pulse energy resp. pulse power for continuous operation

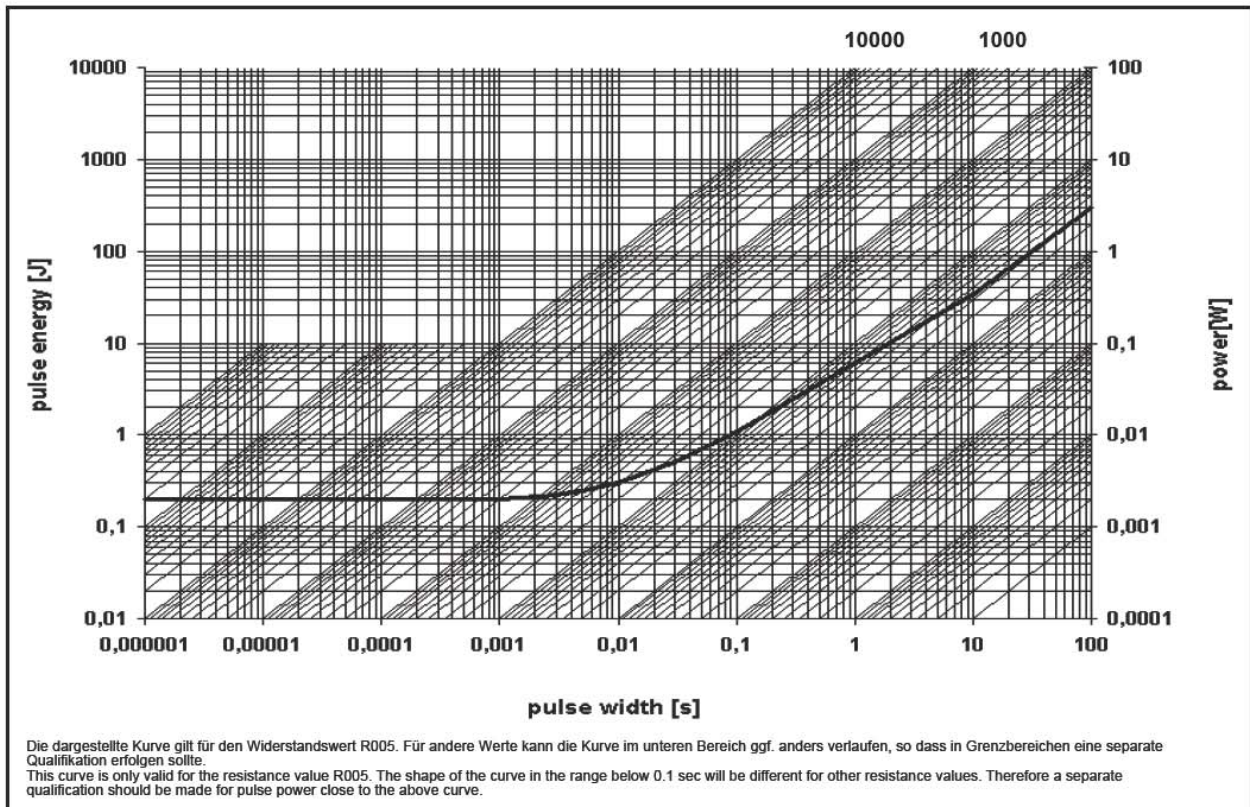

Spezifikation			
Parameters	Test Conditions	Specified values	typical test data
Maximum Temperature for full power operation	110 °C	110 °C	
Working Temperature	-55 to 170 °C	-55 to 170 °C	
Thermal Shock	MIL-STD-202 method 107E-B1	0.1 %	0.05%
Overload	MIL-R-26E (5 times rated power, 5 sec)	0.2 %	0.05%
Solderability	MIL-STD-202 method 208	> 95 % coverage	
Resistance to Solvents	MIL-STD-202 method 215A, 2.1a, 2.1d	no damage	
Low Temperature Storage and Operation	MIL-STD-26E	0.1 %	0.05
Resistance to Soldering Heat	MIL-STD-202 method 210B	0.1 %	0.02
Moisture Resistance	MIL-STD-202 method 106	0.1 %	0.05
Shock	MIL-STD-202 method 213B-A	0.2 %	0.05
Vibration, High Frequency	MIL-STD-202 method 204D-B	0.2 %	0.1
Life	MIL-STD-26E	0.2 %	0.1
Storage Life at Elevated Temperature	MIL-STD-202 method 108A-F	0.5 %	0.2
High Temperature Exposure	140 °C, 2000 h	0.3 %	0.1
Current Noise	MIL-STD-202 method 308	0.01 %	
Voltage Coefficient (%/V)	MIL-STD-202 method 309	linearity error less than 120dB	
Resistance Temperature Characteristic	MIL-STD-202 method 304 (20-60°C)	<20 ppm/K	10 ppm/K
Thermal EMF	0 - 100 °C	2 µV/ °C max.	0.5µ°C
Frequency Characteristic (R<20mOhm)	inductance	< 2 nH	< 0.5