

TSYS01 Digital Temperature Sensor

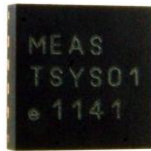

- High Accuracy Temperature Sensor
- 16/24 bit Resolution
- Low Power
- SPI/I2C Interface
- QFN16 Package

DESCRIPTION

The TSYS01 is a single chip, versatile, new technology temperature sensor. The TSYS01 provides factory calibrated temperature information. It includes a temperature sensing chip and a 24 bit $\Delta\Sigma$ -ADC. The essence of the digital 24 bit temperature value and the internal factory set calibration values lead to highly accurate temperature information accompanied by high measurement resolution.

The TSYS01 can be interfaced to any microcontroller by an I²C or SPI interface. This microcontroller has to calculate the temperature result based on the ADC values and the calibration parameters.

The basic working principle is:

- Converting temperature into digital 16/24 bit ADC value
- Providing calibration coefficients
- Providing ADC value and calibration coefficients by SPI or I²C interface.

FEATURES

High Accuracy $\pm 0.1^\circ\text{C}$ @ Temp.: $-5^\circ\text{C} \dots +50^\circ\text{C}$
 Adjustment of high accuracy temp. range on request
 Low Current, $< 12.5 \mu\text{A}$ (standby $< 0.14 \mu\text{A}$)
 SPI / I²C Interface
 Small Package: QFN16
 Operating Temperature Range: $-40^\circ\text{C} \dots +125^\circ\text{C}$

APPLICATIONS

Industrial Control
 Replacement of Thermistors and NTCs
 Heating / Cooling Systems
 HVAC

TSYS01 Digital Temperature Sensor

ABSOLUTE MAXIMUM RATINGS

Absolute maximum ratings are limiting values of permitted operation and should never be exceeded under the worst possible conditions either initially or consequently. If exceeded by even the smallest amount, instantaneous catastrophic failure can occur. And even if the device continues to operate satisfactorily, its life may be considerably shortened.

Parameter	Symbol	Conditions	Min	Typ	Max	Unit
Supply Voltage	V _{DD}		-0.3		+3.6	V
Operating Temperature	T _{op}		-40		+125	°C
Storage temperature	T _{stor}		-55		+150	°C
ESD rating	ESD	Human Body Model (HBM) pin to pin incl. V _{DD} & GND	-4		+4	kV
Humidity	Hum		Non condensing			

OPERATING CONDITIONS

Parameter	Symbol	Conditions	Min	Typ	Max	Unit
Operating Supply Voltage	V _{DD}	stabilized	2.2		3.6	V
High Accuracy Supply Voltage	V _{DD}	To achieve Acc1	3.2		3.4	V
Supply Current	I _{DD}	1 sample per second			12.5	μA
Standby current	I _S	No conversion, V _{DD} = 3V T = 25°C T = 85°C		0.02	0.14	μA
				0.70	1.40	μA
Peak Supply Current	I _{DD}	During conversion		1.4		mA
Conversion time	T _{CONV}		7.40	8.22	9.04	ms
Serial Data Clock SPI	F _{SCLK}				20	MHz
Serial Data Clock I ² C	F _{SCL}				400	kHz
V _{DD} Capacitor		Place close to the chip	100nF			

OPERATIONAL CHARACTERISTICS

If not otherwise noted, 3.3V supply voltage is applied.

Parameter	Symbol	Conditions	Min	Typ	Max	Unit
Temp. Measurement Range	T _{RANG}		-40		125	°C
Accuracy 1	T _{ACC1}	-5°C < T < +50°C V _{DD} = 3.2V – 3.4V	-0.1		+0.1	°C
Accuracy 2	T _{ACC2}	-40°C < T < +125°C V _{DD} = 3.2V – 3.4V	-0.5		+0.5	°C
Power Supply Reject Ratio	PSRR	V _{DD} = 2.7 – 3.6 T = 25°C, C = 100nF			0.2	°C
Temperature Resolution	T _{RES}				0.01	°C
Time Constant	T _{liquid}	t ₆₃ (t ₁ → t ₂) t ₁ = 25°C (air 0m/s) t ₂ = 75°C (liquid) PCB 900mm ² x 1.5mm FR4		3		s
	T _{air}	t ₆₃ (t ₁ → t ₂) t ₁ = 25°C (air 0m/s) t ₂ = 75°C (air stream 60m/s) PCB 900mm ² x 1.5mm FR4		4		s
Self Heating	SH ₁	10 samples/s, 60s, still air			0.02	°C

TSYS01 Digital Temperature Sensor

ANALOGUE TO DIGITAL CONVERTER

Parameter	Symbol	Conditions	Min	Typ	Max	Unit
Output Word				24		bit
Conversion Time	t_c		7.40	8.22	9.04	ms

DIGITAL INPUTS (SCLK, SDI, CSB, PS)

Parameter	Symbol	Conditions	Min	Typ	Max	Unit
Input High Voltage	V_{IH}	$V_{DD} = 2.2...3.6V$	$0.7 V_{DD}$		V_{DD}	V
Input Low Voltage	V_{IL}	$V_{DD} = 2.2...3.6V$	$0.0 V_{DD}$		$0.3 V_{DD}$	V
CS low to first SCLK rising	t_{CSL}		21			ns
CS high to first SCLK rising	t_{CSH}		21			ns
SDI setup to first SCLK rising	T_{DSO}		6			ns
SDI hold to first SCLK rising	T_{DO}		6			ns

DIGITAL OUTPUTS (SDA, SDO)

Parameter	Symbol	Conditions	Min	Typ	Max	Unit
Output High Voltage	V_{OH}	$I_{Source} = 1mA$	$0.8 V_{DD}$		V_{DD}	V
Output Low Voltage	V_{OL}	$I_{Sink} = 1mA$	$0.0 V_{DD}$		$0.2 V_{DD}$	V
SDO setup to first SCLK rising	t_{QS}		10			ns
SDO hold to first SCLK rising	t_{QH}		0			ns

TSYS01 Digital Temperature Sensor

CONNECTION DIAGRAM

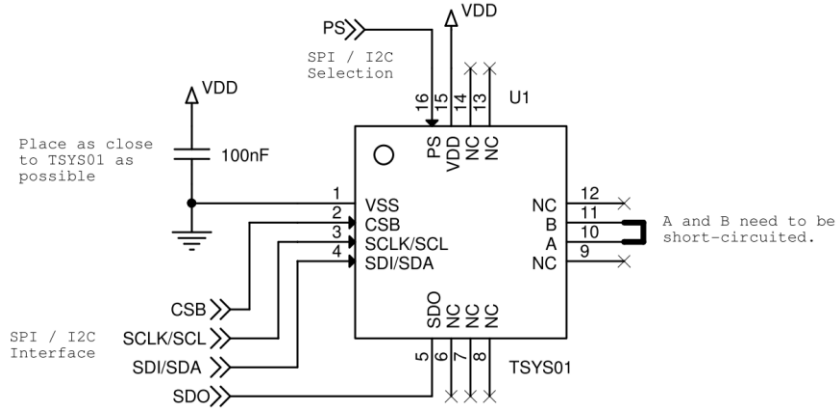

PIN FUNCTION TABLE

Pin	Name	Type	Function
1	VSS	G	Ground
2	CSB	DI	SPI: Chip Select (active low) I ² C: Address Selection
3	SCLK/SCL	DI	SPI: Serial Data Clock I ² C: Serial Data Clock
4	SDI/SDA	DIO	SPI: Serial Data Input I ² C: Data Input / Output
5	SDO	DO	SPI: Serial Data Output
6 – 9	NC	---	Not connected / Do not connect
10	A	I	Connect Pin10 with Pin11
11	B	I	Connect Pin11 with Pin10
12 – 14	NC	---	Not connected / Do not connect
15	VDD	P	Supply Voltage
16	PS	DI	Communication protocol select (0=SPI, 1=I ² C)

TSYS01 Digital Temperature Sensor

INTERFACE DESCRIPTION

PROTOCOL SELECTION

PS pin input level has to be defined in dependence to protocol selection.

- PS = 0 activates SPI.
- PS = 1 activates I²C.

I²C INTERFACE

A I²C communication message starts with a start condition and it is ended by a stop condition. Each command consists of two bytes: the address byte and command byte.

I²C ADDRESS SELECTION

The I²C address can be selected by CSB pin.

- CSB=1 then the address is 1110110x.
- CSB=0 the address is 1110111x.

Therefore, two TSYS01 can be interfaced on the same I²C bus.

SPI INTERFACE

The serial interface is a 4-wire SPI bus, operating as a slave. CS (chip select), SCLK (serial clock), SDI (serial data in), and SDO (serial data out) are used to interact with the SPI master.

Communication with the chip starts when CS is pulled to low and ends when CS is pulled to high.

SCLK is controlled by the SPI master and idles low (SCLK low on CS transitions, mode 0).

A mode where the clock alternatively idles high is also supported (mode 3).

COMMANDS

The commands are the same for SPI and I²C interface.

There are four commands:

- Reset
- Read PROM (calibration parameters)
- Start ADC Temperature conversion
- Read ADC Temperature result

Command	Hex Value
Reset	0x1E
Start ADC Temperature Conversion	0x48
Read ADC Temperature Result	0x00
PROM Read Address 0	0xA0
PROM Read Address 1	0xA2
PROM Read Address 2	0xA4
PROM Read Address 3	0xA6
PROM Read Address 4	0xA8
PROM Read Address 5	0xAA
PROM Read Address 6	0xAC
PROM Read Address 7	0xAE

TSYS01 Digital Temperature Sensor

RESET SEQUENCE

The Reset sequence has to be sent once after power-on. It can be also used to reset the device ROM from an unknown condition.

SPI

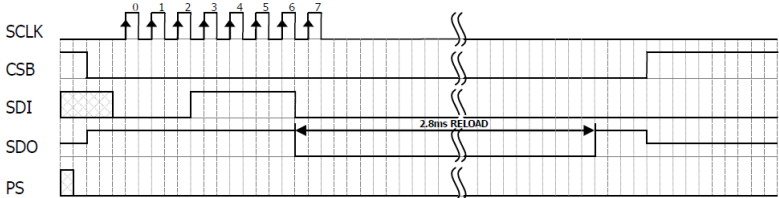

I²C

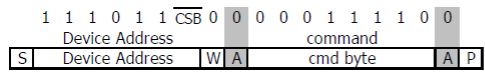

From Master S = Start Condition W = Write A = Acknowledge
 From Slave P = Stop Condition R = Read N = Not Acknowledgement

PROM READ SEQUENCE

The PROM Read command consists of two parts. First command sets up the system into PROM read mode. The second part gets the data from the system.

Below examples are sequences to read address 3 (command 0xA6).

SPI

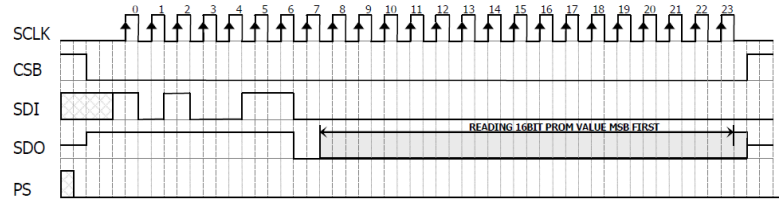

I²C

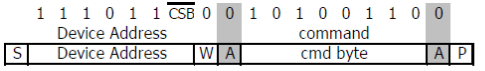

From Master S = Start Condition W = Write A = Acknowledge
 From Slave P = Stop Condition R = Read N = Not Acknowledgement

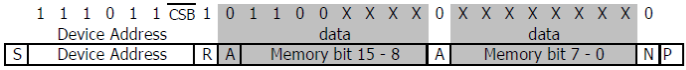

From Master S = Start Condition W = Write A = Acknowledge
 From Slave P = Stop Condition R = Read N = Not Acknowledgement

TSYS01 Digital Temperature Sensor

CONVERSION SEQUENCE

A conversion has to be started by sending this command. The sensor stays busy until conversion is done. When conversion is finished the data can be accessed by using ADC read command

SPI

The last clock will start the conversion which TSYS01 indicates by pulling SDO low. SDO goes high when conversion is completed.

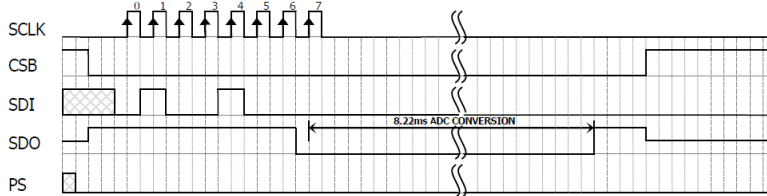

I²C

When the command is sent the TSYS01 stays busy until the conversion is done. All other commands except the reset command will not be executed during this time. When the conversion is finished the data can be accessed by sending a ADC read command, when an acknowledge appears from TSYS01.

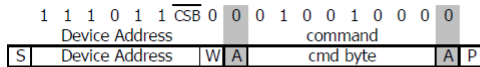

From Master S = Start Condition W = Write A = Acknowledge
 From Slave P = Stop Condition R = Read N = Not Acknowledge

READ ADC RESULT

After the conversion command the ADC result is read using ADC read command. Repeated ADC read commands, or command executed without prior conversion will return all 0 as result.

SPI

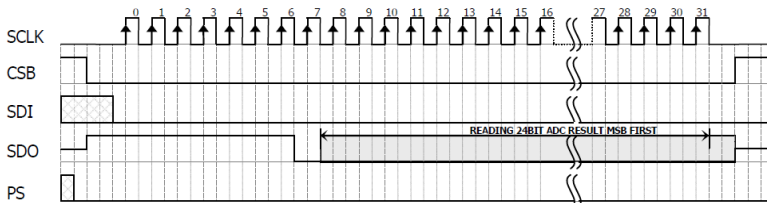

I²C

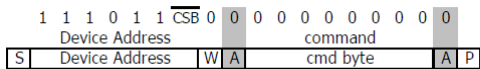

From Master S = Start Condition W = Write A = Acknowledge
 From Slave P = Stop Condition R = Read N = Not Acknowledge

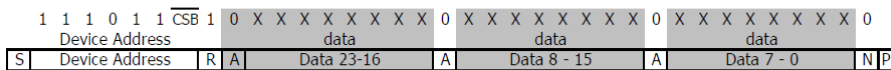

From Master S = Start Condition W = Write A = Acknowledge
 From Slave P = Stop Condition R = Read N = Not Acknowledge

TSYS01 Digital Temperature Sensor

TEMPERATURE CALCULATION

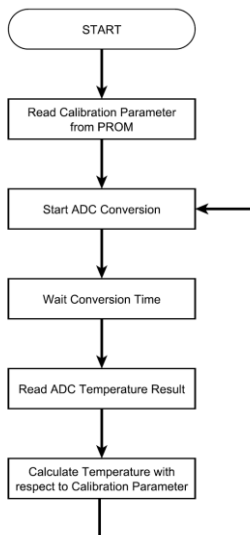

CALIBRATION PARAMETER

Variable	Description	Command	Size / bit	Min	Max	Example
k ₄	Coefficient k ₄ of polynomial	0xA2	16	0	65535	28446
k ₃	Coefficient k ₃ of polynomial	0xA4	16	0	65535	24926
k ₂	Coefficient k ₂ of polynomial	0xA6	16	0	65535	36016
k ₁	Coefficient k ₁ of polynomial	0xA8	16	0	65535	32791
k ₀	Coefficient k ₀ of polynomial	0xAA	16	0	65535	40781

TEMPERATURE POLYNOMIAL

ADC24: ADC value
ADC16: ADC24 / 256

$$T / ^\circ\text{C} = (-2) \cdot k_4 \cdot 10^{-21} \cdot \text{ADC16}^4 + 4 \cdot k_3 \cdot 10^{-16} \cdot \text{ADC16}^3 + (-2) \cdot k_2 \cdot 10^{-11} \cdot \text{ADC16}^2 + 1 \cdot k_1 \cdot 10^{-6} \cdot \text{ADC16} + (-1.5) \cdot k_0 \cdot 10^{-2}$$

EXAMPLE

ADC24: 9378708
ADC16: 9378708 / 256 = 36636

$$T / ^\circ\text{C} = (-2) \cdot 28446 \cdot 10^{-21} \cdot 36636^4 + 4 \cdot 24926 \cdot 10^{-16} \cdot 36636^3 + (-2) \cdot 36016 \cdot 10^{-11} \cdot 36636^2 + 1 \cdot 32791 \cdot 10^{-6} \cdot 36636 + (-1.5) \cdot 40781 \cdot 10^{-2}$$

$$T / ^\circ\text{C} = \underline{10.59}$$

TSYS01 Digital Temperature Sensor

DIMENSIONS

TOP VIEW

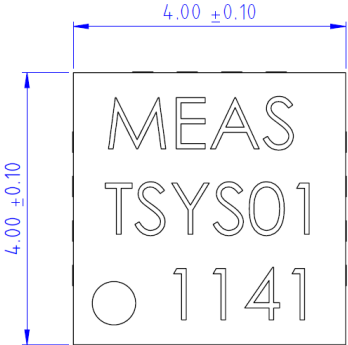

SIDE VIEW

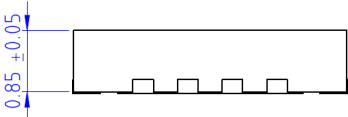

BOTTOM VIEW

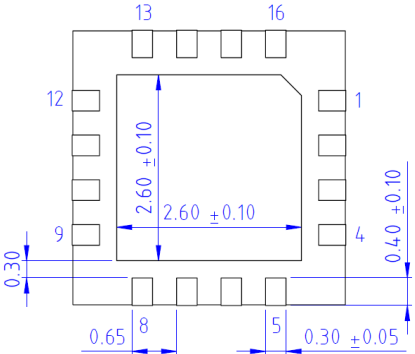

MARKING

Line	Description	Example
1	Manufacturer	MEAS
2	Product Name	TSYS01
3	Pin 1 Dot, Date Code YYWW	1141

