



N-Channel MOSFET

Pb Lead Free Package and Finish

Applications:

- Adaptor
- Charger
- SMPS Standby Power
- LCD Panel Power

V_{DSS}	$R_{DS(ON)}$ (Typ.)	I_D
650V	4.0 Ω	2.0A

Features:

- RoHS Compliant
- Low ON Resistance
- Low Gate Charge
- Peak Current vs Pulse Width Curve
- Inductive Switching Curves

Ordering Information

PART NUMBER	PACKAGE	BRAND
KR02N65U	TO-251	KR
KR02N65D	TO-252	KR

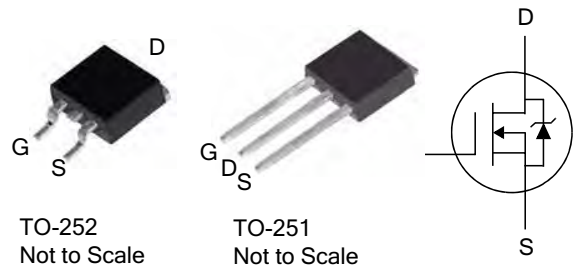

Absolute Maximum Ratings $T_C=25\text{ }^\circ\text{C}$ unless otherwise specified

Symbol	Paramete	KR02N65U	KR02N65D	Units
V_{DSS}	Drain-to-Source Voltage (NOTE *1)	650		V
I_D	Continuous Drain Current	2.0	2.0*	A
$I_{D@100\text{ }^\circ\text{C}}$	Continuous Drain Current	Figure 3		
I_{DM}	Pulsed Drain Current, $V_{GS}@10\text{V}$ (NOTE *2)	Figure 6		
P_D	Power Dissipation	55	55	W
	Derating Factor above 25 $^\circ\text{C}$	0.43	0.43	W/ $^\circ\text{C}$
V_{GS}	Gate-to-Source Voltage	± 30		V
E_{AS}	Single Pulse Avalanche Energy L=10 mH	68		mJ
I_{AS}	Pulsed Avalanche Rating	Figure 8		
dv/dt	Peak Diode Recovery dv/dt (NOTE *3)	5.0		V/ns
T_L T_{PKG}	Maximum Temperature for Soldering Leads at 0.063in (1.6mm) from Case for 10 seconds Package Body for 10 seconds	300 260		$^\circ\text{C}$
T_J and T_{STG}	Operating Junction and Storage Temperature Range	-55 to 150		

*Drain Current limited by Maximum Junction Temperature.

Caution: Stresses greater than those listed in the "Absolute Maximum Ratings" Table may cause permanent damage to the device.

Thermal Resistance

Symbol	Parameter	KR02N65U	KR02N65D	Units	Test Conditions
$R_{\theta JC}$	Junction-to-Case	2.3	2.3	$^\circ\text{C/W}$	Water cooled heatsink, P_D adjusted for a peak junction temperature of +150 $^\circ\text{C}$.
$R_{\theta JA}$	Junction-to-Ambient	100	100		1 cubic foot chamber, free air.

OFF Characteristics $T_c=25^\circ\text{C}$ unless otherwise specified

Symbol	Parameter	Min.	Typ.	Max.	Units	Test Conditions
BV_{DSS}	Drain-to-Source Breakdown Voltage	650	--	--	V	$V_{GS}=0V, I_D=250\mu A$
$\Delta BV_{DSS}/\Delta T_J$	Breakdown Voltage Temperature Coefficient, Figure 11.	--	0.60	--	V/°C	Reference to 25°C , $I_D=250\mu A$
I_{DSS}	Drain-to-Source Leakage Current	--	--	1.0	μA	$V_{DS}=650V, V_{GS}=0V$
		--	--	250		$V_{DS}=520V, V_{GS}=0V$ $T_J=125^\circ\text{C}$
I_{GSS}	Gate-to-Source Forward Leakage	--	--	100	nA	$V_{GS}=+30V$
	Gate-to-Source Reverse Leakage	--	--	-100		$V_{GS}=-30V$

ON Characteristics $T_c=25^\circ\text{C}$ unless otherwise specified

Symbol	Parameter	Min.	Typ.	Max.	Units	Test Conditions
$R_{DS(ON)}$	Static Drain-to-Source On-Resistance Figure 9 and 10.	--	4.0	5.0	Ω	$V_{GS}=10V, I_D=1.0A$ (NOTE *4)
$V_{GS(TH)}$	Gate Threshold Voltage, Figure 12.	2.0	--	4.0	V	$V_{DS}=V_{GS}, I_D=250\mu A$
gfs	Forward Transconductance	--	2.6	--	S	$V_{DS}=15V, I_D=2.0A$ (NOTE *4)

Dynamic Characteristics Essentially independent of operating temperature

Symbol	Parameter	Min.	Typ.	Max.	Units	Test Conditions
C_{iss}	Input Capacitance	--	290	--	pF	$V_{GS}=0V$ $V_{DS}=25V$ $f=1.0\text{MHz}$ Figure 14
C_{oss}	Output Capacitance	--	31	--		
C_{rss}	Reverse Transfer Capacitance	--	6.0	--		
Q_g	Total Gate Charge	--	9.0	--	nC	$V_{DD}=325V$ $I_D=2.0A$ Figure 15
Q_{gs}	Gate-to-Source Charge	--	1.5	--		
Q_{gd}	Gate-to-Drain ("Miller") Charge	--	4	--		

Resistive Switching Characteristics Essentially independent of operating temperature

Symbol	Parameter	Min.	Typ.	Max.	Units	Test Conditions
$t_{d(ON)}$	Turn-on Delay Time	--	8.0	--	ns	$V_{DD}=325V$ $I_D=2.0A$ $V_{GS}=10V$ $R_G=9.1\Omega$
t_{rise}	Rise Time	--	6.0	--		
$t_{d(OFF)}$	Turn-Off Delay Time	--	30	--		
t_{fall}	Fall Time	--	11	--		

Source-Drain Diode Characteristics $T_C=25^\circ\text{C}$ unless otherwise specified

Symbol	Parameter	Min.	Typ.	Max.	Units	Test Conditions
I_S	Continuous Source Current (Body Diode)	--	--	2.0	A	Integral pn-diode in MOSFET
I_{SM}	Maximum Pulsed Current (Body Diode)	--	--	8.0	A	
V_{SD}	Diode Forward Voltage	--	--	1.5	V	$I_S=2.0\text{A}$, $V_{GS}=0\text{V}$
t_{rr}	Reverse Recovery Time	--	425	--	ns	$V_{GS}=0\text{V}$
Q_{rr}	Reverse Recovery Charge	--	1.14	--	μC	$I_F=2.0\text{A}$, $di/dt=100\text{A}/\mu\text{s}$

Notes:

- *1. $T_J = +25^\circ\text{C}$ to $+150^\circ\text{C}$.
- *2. Repetitive rating; pulse width limited by maximum junction temperature.
- *3. $I_{SD}= 2.0\text{A}$ $di/dt \leq 100\text{A}/\mu\text{s}$, $V_{DD} \leq BV_{DSS}$, $T_J=+150^\circ\text{C}$.
- *4. Pulse width $\leq 380\mu\text{s}$; duty cycle $\leq 2\%$.

Typical Characteristics

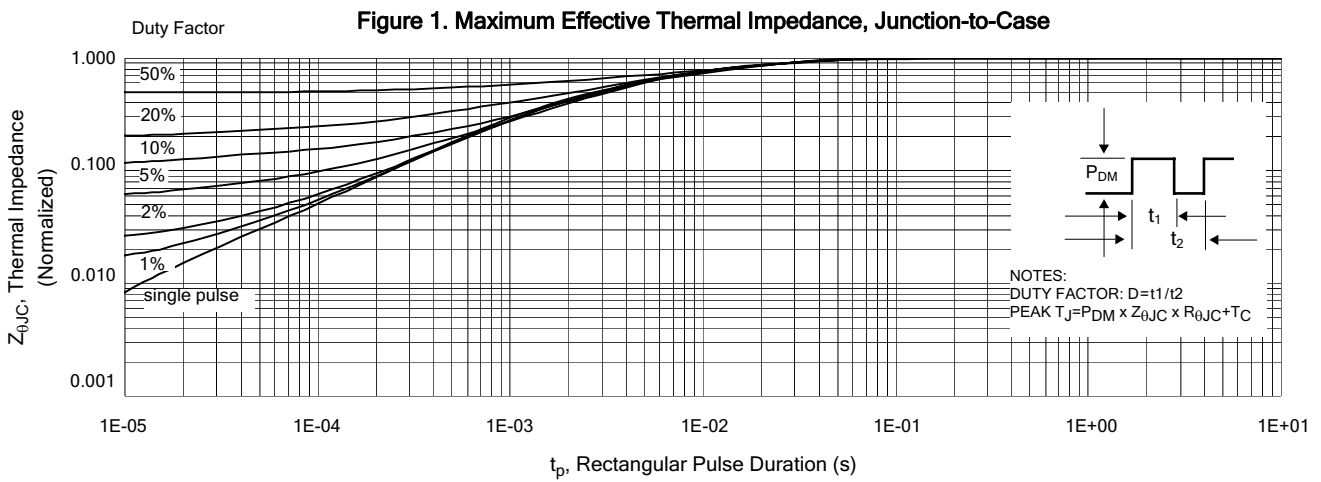

Figure 2. Maximum Power Dissipation vs Case Temperature

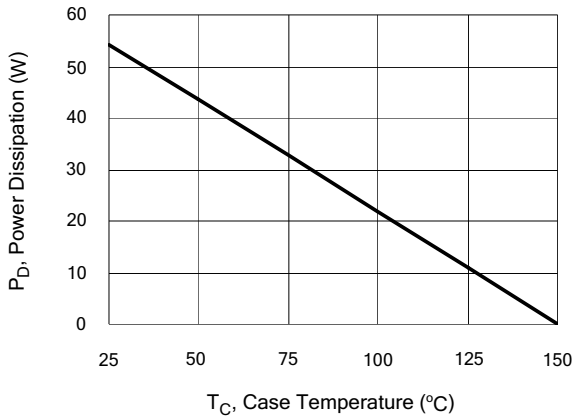

Figure 3. Maximum Continuous Drain Current vs Case Temperature

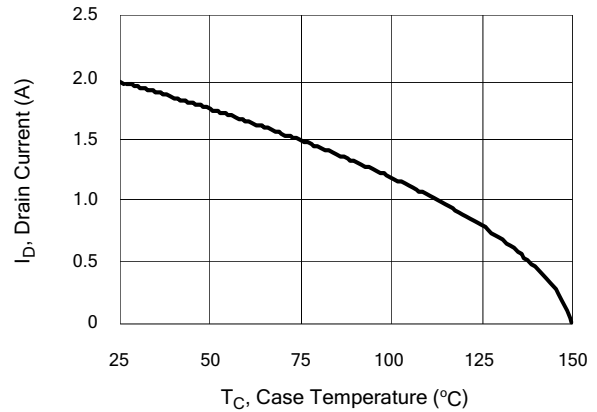

Figure 4. Typical Output Characteristics

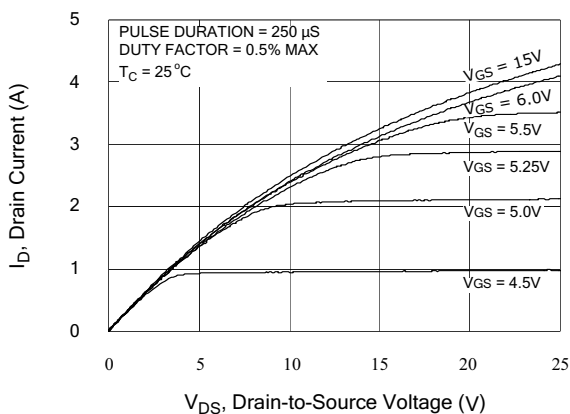

Figure 5. Typical Drain-to-Source ON Resistance vs Gate Voltage and Drain Current

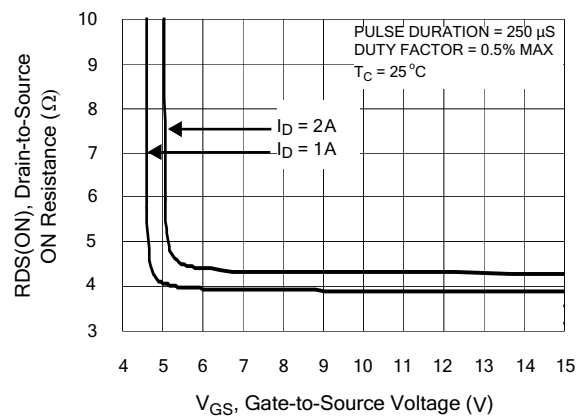

Figure 6. Maximum Peak Current Capability

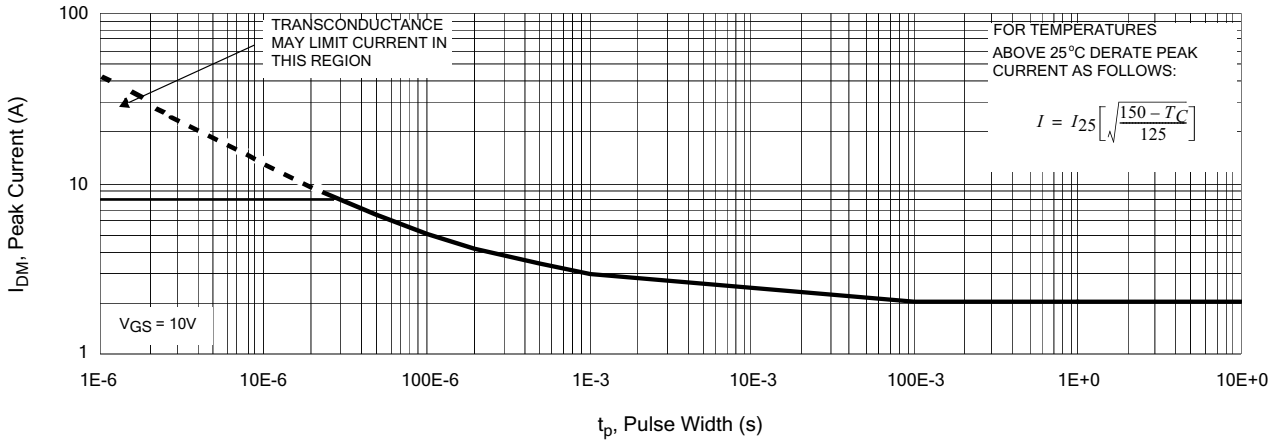

Figure 7. Typical Transfer Characteristics

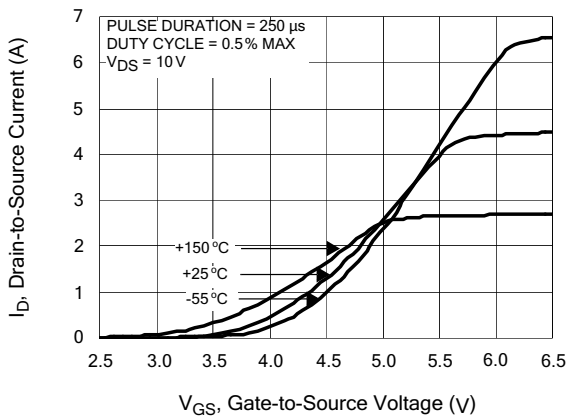

Figure 8. Unclamped Inductive Switching Capability

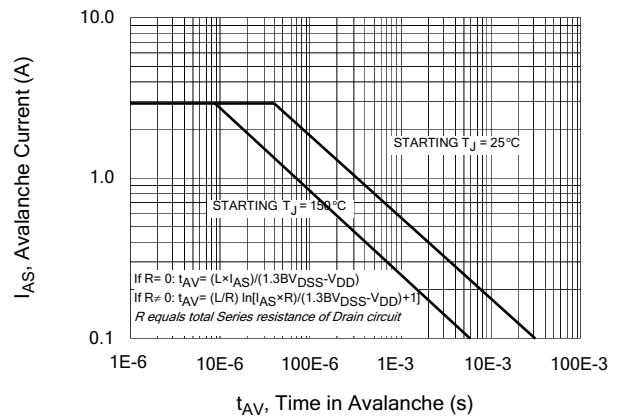

Figure 9. Typical Drain-to-Source ON Resistance vs Drain Current

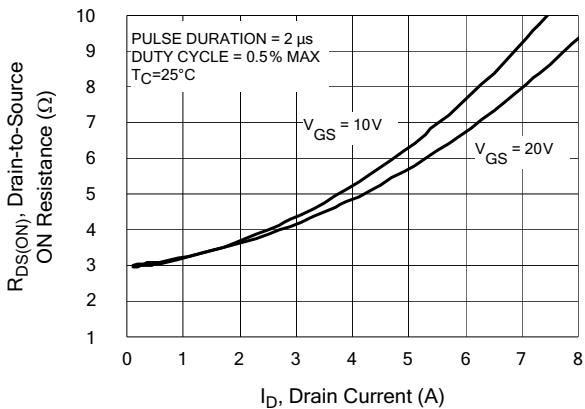

Figure 10. Typical Drain-to-Source ON Resistance vs Junction Temperature

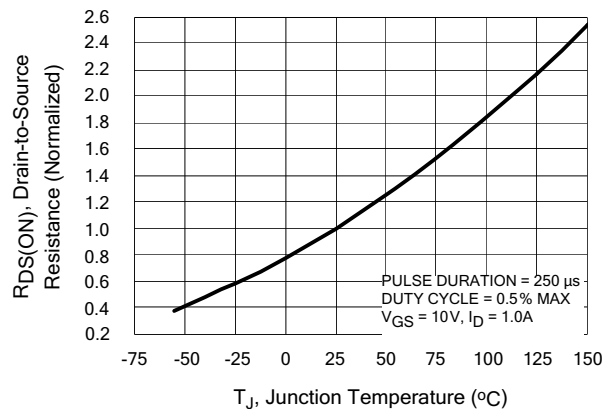

Figure 11. Typical Breakdown Voltage vs Junction Temperature

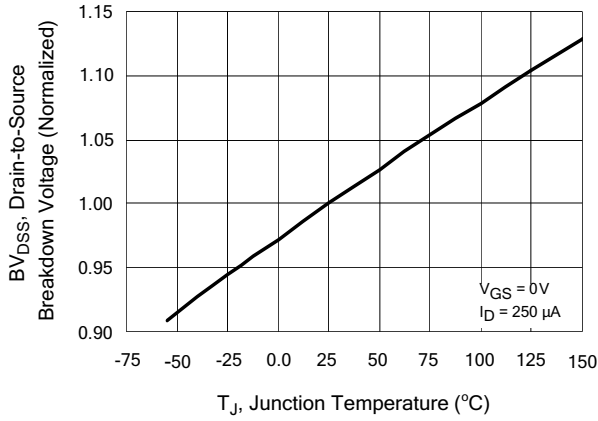

Figure 12. Typical Threshold Voltage vs Junction Temperature

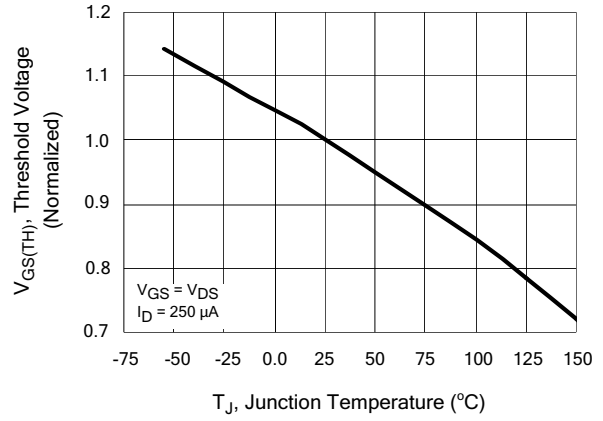

Figure 13. Maximum Forward Bias Safe Operating Area

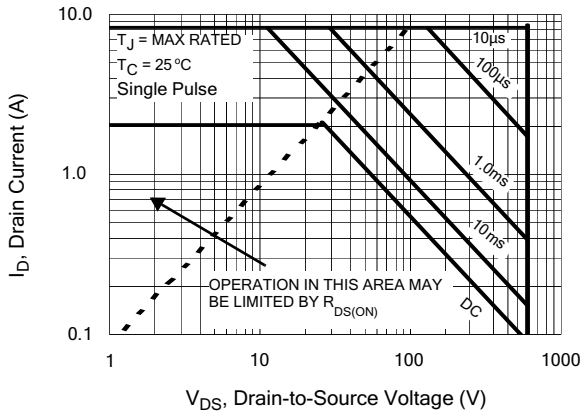

Figure 14. Typical Capacitance vs Drain-to-Source Voltage

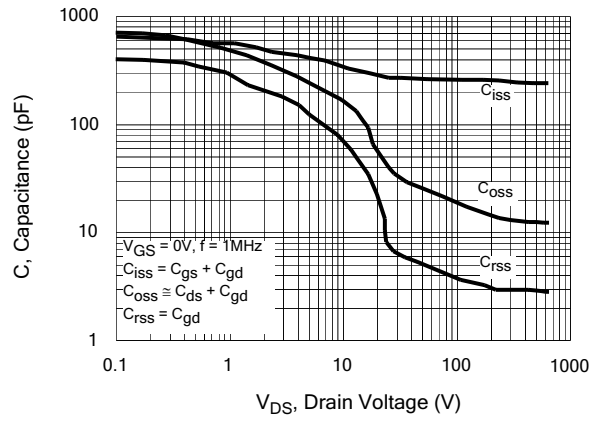

Figure 15. Typical Gate Charge vs Gate-to-Source Voltage

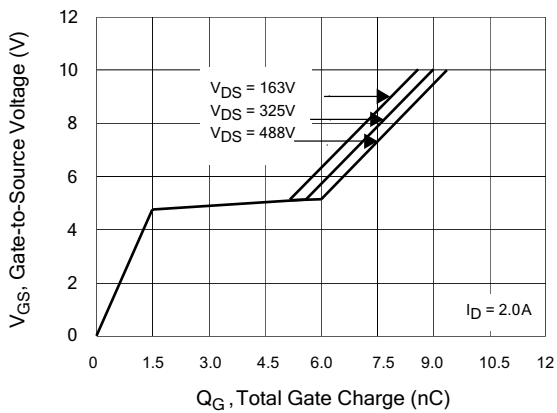
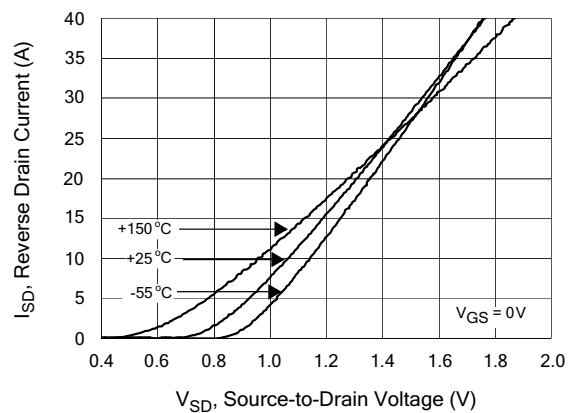

Figure 16. Typical Body Diode Transfer Characteristics



TEST CIRCUITS AND WAVEFORMS

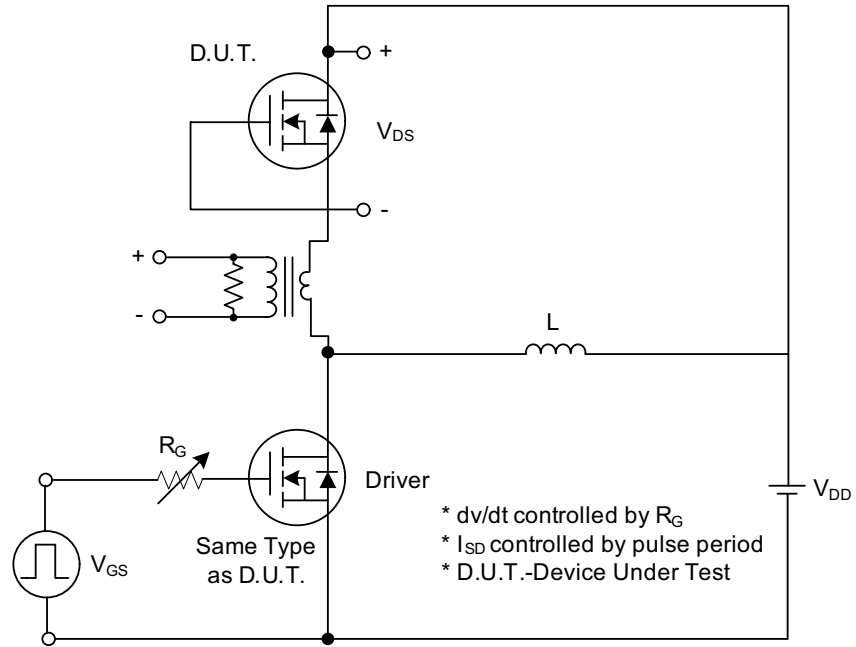

Fig. 1.1 Peak Diode Recovery dv/dt Test Circuit

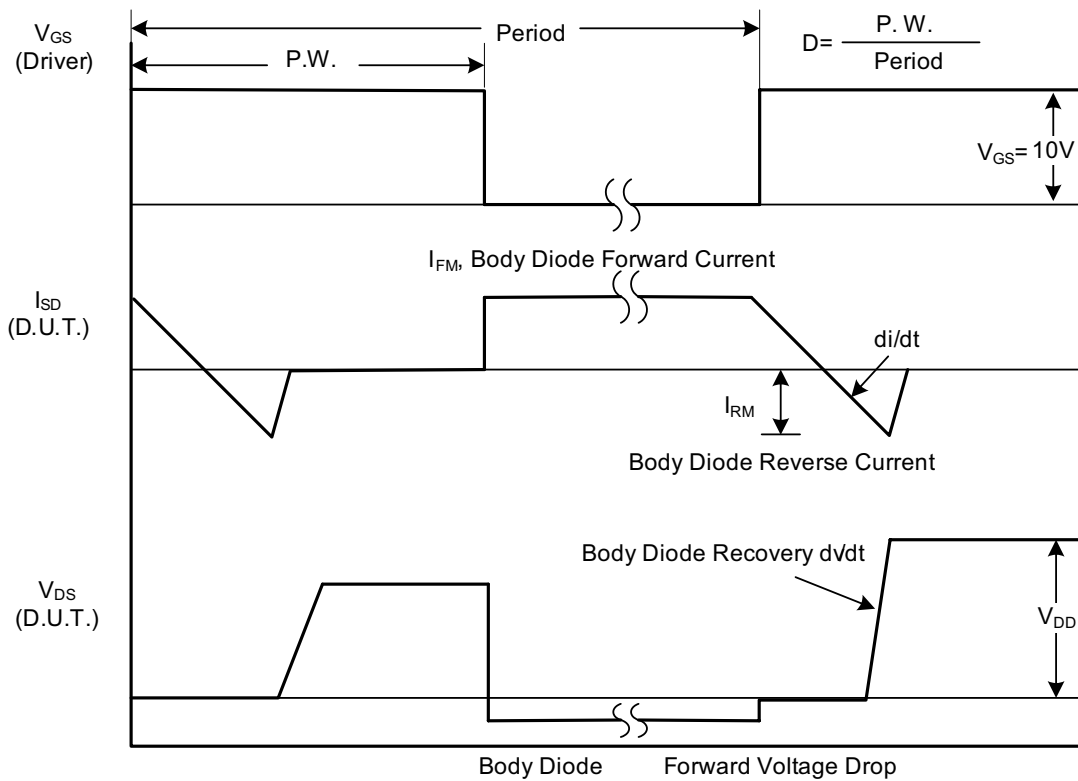

Fig. 1.2 Peak Diode Recovery dv/dt Waveforms

TEST CIRCUITS AND WAVEFORMS (Cont.)

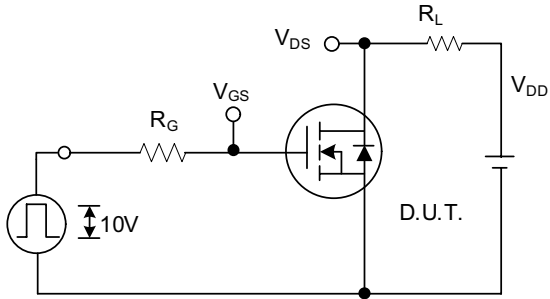

Fig. 2.1 Switching Test Circuit

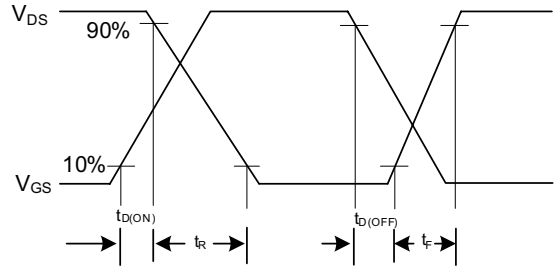

Fig. 2.2 Switching Waveforms

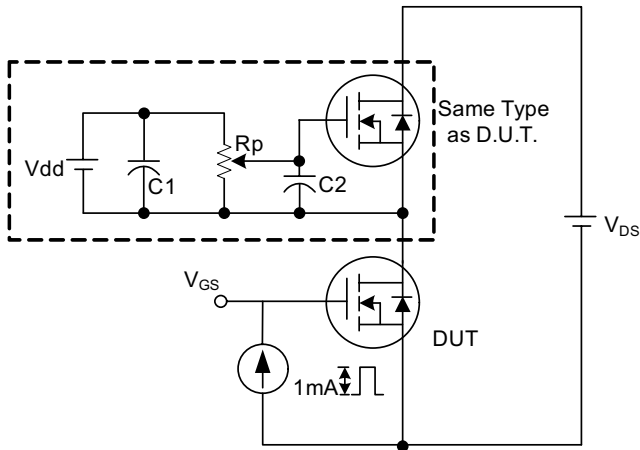

Fig. 3.1 Gate Charge Test Circuit

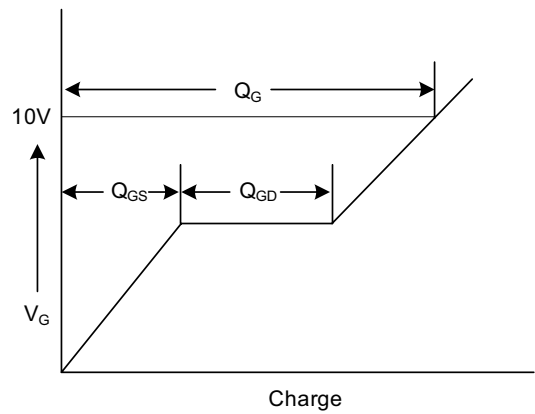

Fig. 3.2 Gate Charge Waveform

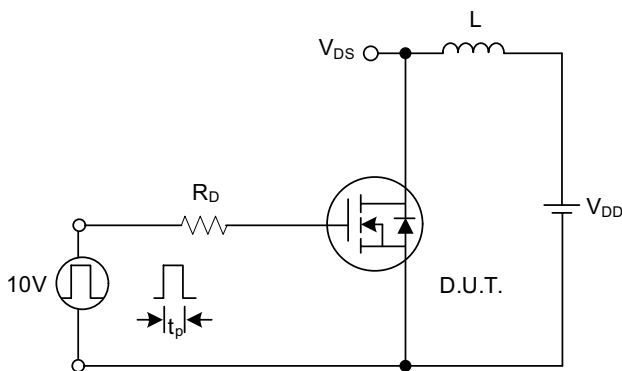

Fig. 4.1 Unclamped Inductive Switching Test Circuit

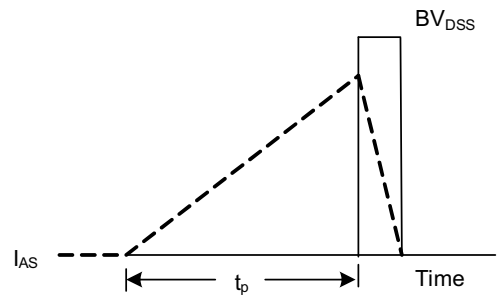

Fig. 4.2 Unclamped Inductive Switching Waveforms