

---

# LCD&LCM SPECIFICATION

## 液晶显示屏产品使用说明书

**MODULE NO.**

**12864C042**

128x64 图形点阵

COG 工艺

SPI 串口通讯

Designed	Checked	Approved

**Revision history 修改记录**

revision	date	description	remark
A00	2011-08-01	First release	
A01	2013-06-28	含背光 BL3	

## Content/目录

1. **Feature/显示特性**
2. **Mechanical specifications/外形尺寸说明**
3. **Block diagram & power supply/电路原理图**
4. **Pin description/PIN 脚描述**
5. **Absolute maximum rating/限定参数**
6. **Electrical characteristics/电气特性**
7. **Backlight characteristics/背光特性**
8. **Electrical-optical characteristics/光学特性**
9. **Control and display commands/指令描述**
10. **DDRAM 映射表**
11. **Inspection standards/检验标准**
12. **Handling precautions/注意事项**

## 1. Feature/显示特性

- Display resolution/点阵数 : 128(w)\*64(h)
- Display mode/显示模式 : FSTN ,Positive, Transflective
- Driving method/驱动方式 : 1/64 Duty , 1/9 Bias
- Viewing direction/视角 : 6:00 o'clock
- Backlight/背光 : LED , White(or Green,Blue,Other)
- Built-in controller/控制器 : ST7565R
- Operation temp/工作温度 : 0°C~50°C
- Storage temp/储存温度 : -10°C~60°C

## 2. Mechanical Specifications/外形尺寸说明

### 2.1 尺寸描述

- Dimensional outline (W\*H\*T)/外形尺寸 : 36.6mm\*28.0mm\*4.0mm
- Viewing area (W\*H)/视域尺寸 : 34.6mm\*22.5mm
- Dot pitch (W\*H)/点距 : 0.242mm\*0.309mm
- Dot size (W\*H)/点大小 : 0.217mm\*0.284mm

### 2.2 Outline Dimension 外形尺寸图

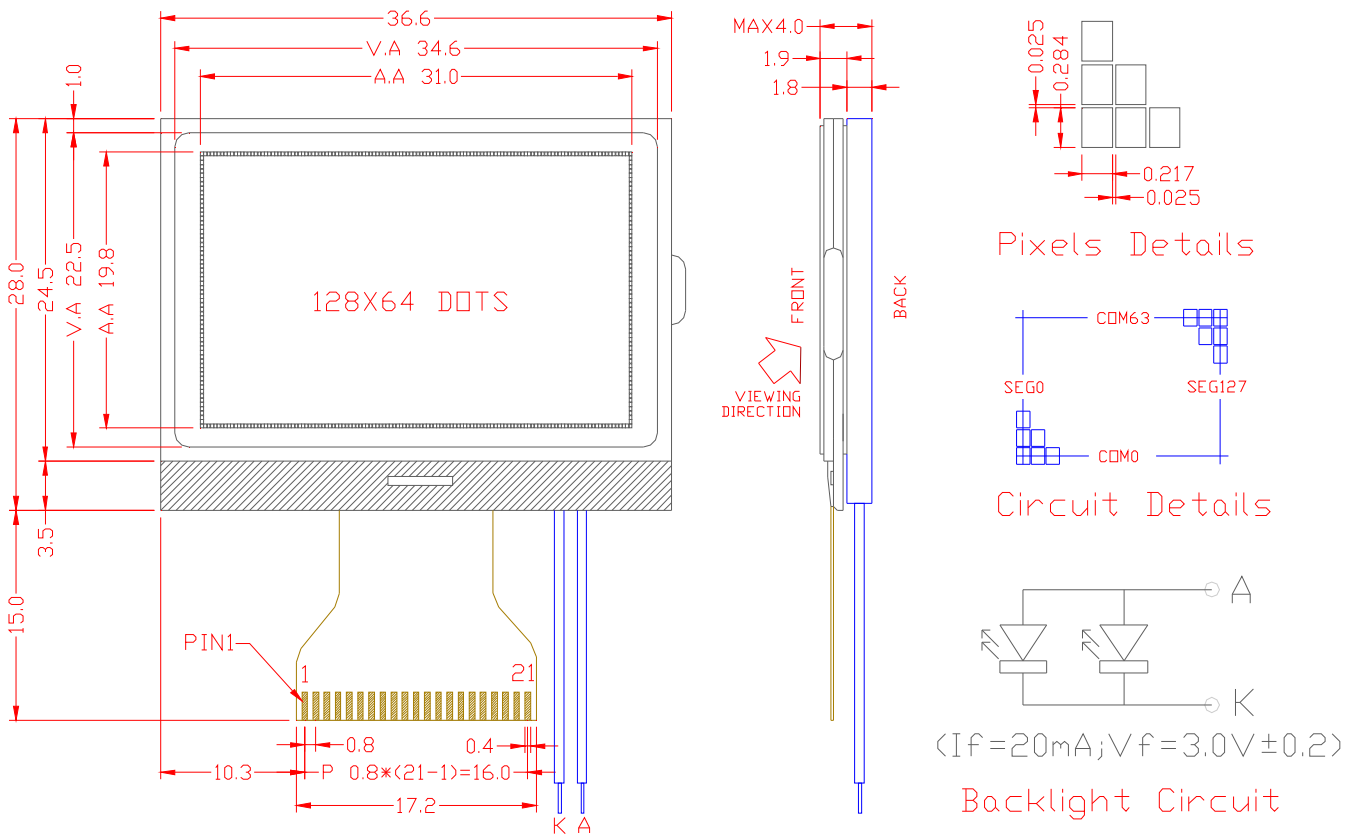

### 3. Block Diagram & Power supply/电路原理图

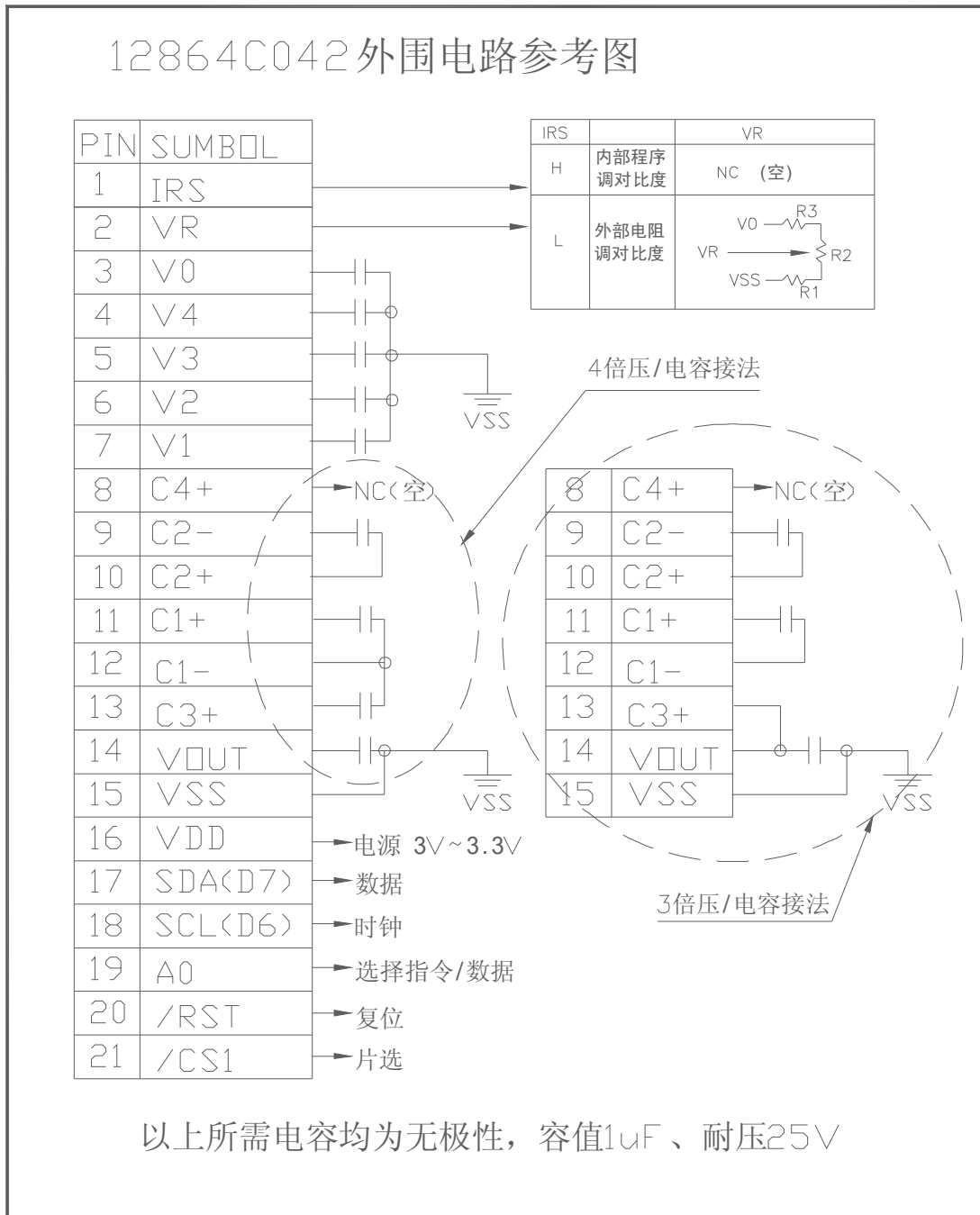

### 4. Pin description/PIN 脚描述

#### LED 背光引脚

A	LED 正极，供电电压+3.0V，工作电流 20mA~30mA，最大不能超过 30mA。如用 IO 口控制，需加三极管开关放大电路。
K	LED 负极，0V，或接 VSS。

Pin No.	Pin Name	Function
1	IRS	This terminal selects the resistors for the V0 voltage level adjustment. 选择内部调对比度或外部调对比度
2	VR	Output voltage regulator terminal. 外部调对比度接电阻位
3~7	V0、V4、V3、V2、V1	LCD driving voltages. 分压电路
8~13	C4+、C2-、C2+、C1+、C1-、C3+	When internal DC-DC voltage converter is used, external capacitor is connected between these pins. 升压电路接电容
14	VOUT	positive voltage supply pin of the chip. 升压输出, 对地接电容
15	VSS	Negative power supply,0V 地 0V
16	VDD	Power supply voltage (Positive) 电源 3~3.3V
17	SI (D7)	(D7) Serial data input SPI数据
18	SCL (D6)	(D6) The serial clock input SPI串口时钟
19	A0	Data/Command control 选择指令或数据
20	/RES	Rester 复位
21	/CS1	Chip selection input 片选

## 5. Absolute Maximum Ratings/限定参数

Items	Symbol	MIN.	MAX.	Unit	Condition
Supply Voltage/供电电压	V <sub>DD</sub>	-0.3	+3.0	V	V <sub>SS</sub> = 0V
	V <sub>lcd</sub>	-0.3	+10.0	V	V <sub>SS</sub> = 0V
Input Voltage/输入电压	V <sub>IN</sub>	-0.3	V <sub>DD</sub> +0.3	V	V <sub>SS</sub> = 0V
LED forward current/背光电流	I <sub>f</sub>	0	30	mA	---
Operating Temp./工作温度	T <sub>OP</sub>	0	+50	°C	---
Storage Temp./储存温度	T <sub>st</sub>	-10	+60	°C	---

## 6. Electrical Characteristics/电气特性

### 6.1 Typical Electrical Characteristics (V<sub>SS</sub> = 0V, V<sub>DD</sub> = 3.3V ± 10%, T<sub>OP</sub> = 25 °C)

Items	Symbol	MIN.	TYP.	MAX.	Unit	Condition Pin
Operating Voltage/工作电压	V <sub>DD</sub>	2.7	3.0	3.3	V	V <sub>DD</sub>
LCD Operating Voltage	V <sub>op</sub>	-	10.0	-	V	V <sub>0</sub>
Input High Voltage/输入高电压	V <sub>IH</sub>	0.8 V <sub>DD</sub>	-	V <sub>DD</sub>	V	AO,W/R,RD, D0~D7
Input Low Voltage 输入低电压	V <sub>IL</sub>	0	-	0.4 V <sub>DD</sub>	V	
Output High Voltage 输出高电压	V <sub>OH</sub>	0.7	-	V <sub>DD</sub>	V	D0~D7
Output Low Voltage 输出低电压	V <sub>OL</sub>	0	-	0.2	V	D0~D7
Supply Current/供电电流	I <sub>DD</sub>	---	0.6	8	mA	V <sub>DD</sub> ,V <sub>SS</sub>

Note 1: There is tolerance in optimum LCD driving voltage during production and it will be within the specified range.

## 6.2. Timing Specifications

The 4-line SPI Interface

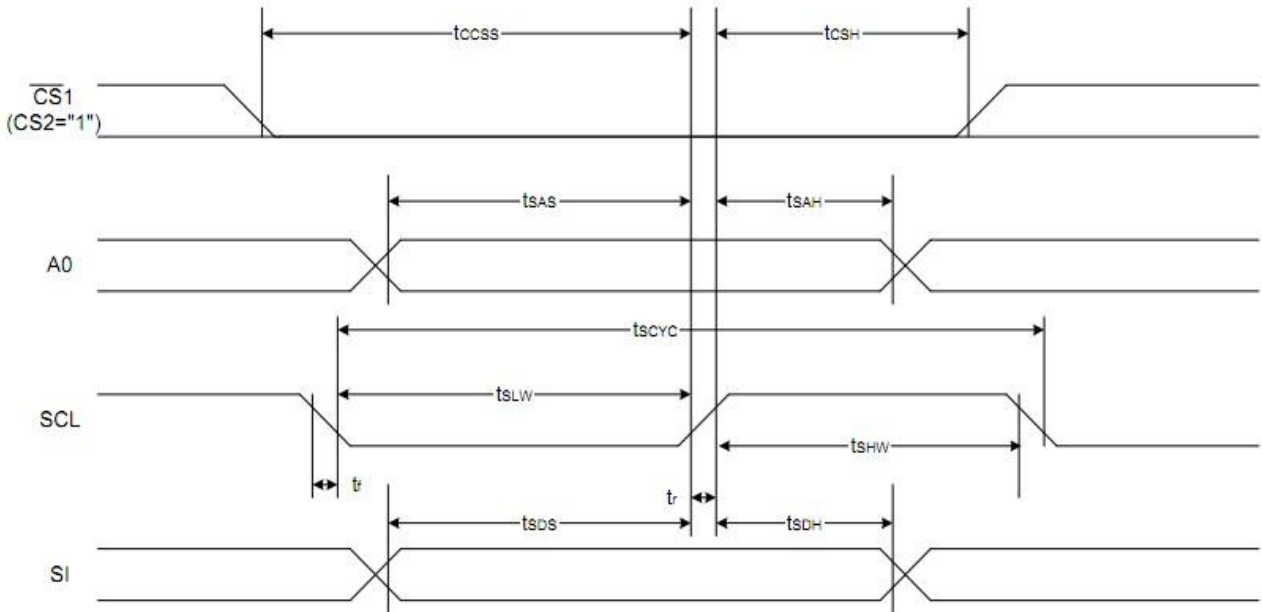

Item	Signal	Symbol	Condition	Rating		Units
				Min.	Max.	
4-line SPI Clock Period	SCL	$T_{scyc}$		100	—	ns
SCL "H" pulse width		$T_{SHW}$		50	—	
SCL "L" pulse width		$T_{SLW}$		50	—	
Address setup time	A0	$T_{SAS}$		30	—	
Address hold time		$T_{SAH}$		20	—	
Data setup time	SI	$T_{SDS}$		30	—	
Data hold time		$T_{SDH}$		20	—	
CS-SCL time	CS	$T_{CSS}$		30	—	
CS-SCL time		$T_{CSH}$		60	—	

### 6.2.4 Reset timing

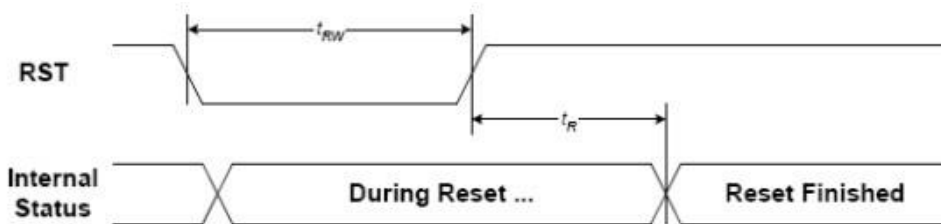

FIGURE 15: Reset Characteristics

( $1.65V \leq V_{DD} < 3.3V$ ,  $T_a = -30$  to  $+85^\circ C$ )

Symbol	Signal	Description	Condition	Min.	Max.	Units
$t_{RW}$	RST	Reset low pulse width		3	—	$\mu S$
$t_R$	RST,, Internal Status	Reset to Internal Status pulse delay		6	—	mS

## 7. Backlight Characteristics/背光特性

Items	Symbol	MIN.	TYP.	MAX.	Unit	Condition
Forward Voltage/电压	Vf	2.8	3.0	3.1	V	If=20mA
Reverse current/电流	Ir	---	20	30	mA	Vr=3V
Peak wave length/波长	$\lambda$	---	---	---	nM	If=20mA
Luminance/亮度	Lv	---	---	---	Cd/m <sup>2</sup>	If=20mA
Color /颜色	White (白色, 或者其他色)					

## 8. Electrical-Optical Characteristics/光学特性

Items	Symbol	Condition	MIN.	TYP.	MAX.	Unit	NOTE
Response time/反应时间	Tr	Ta= 25°C	---	185	---	ms	2
	Tf		---	200	---		
Contrast ratio/对比度	Cr	Ta= 25°C	---	--	---		3
Viewing angle range/视角范围	$\theta$	Cr $\geq$ 2	-40	---	40	degree	

Note 1. Definition of response time

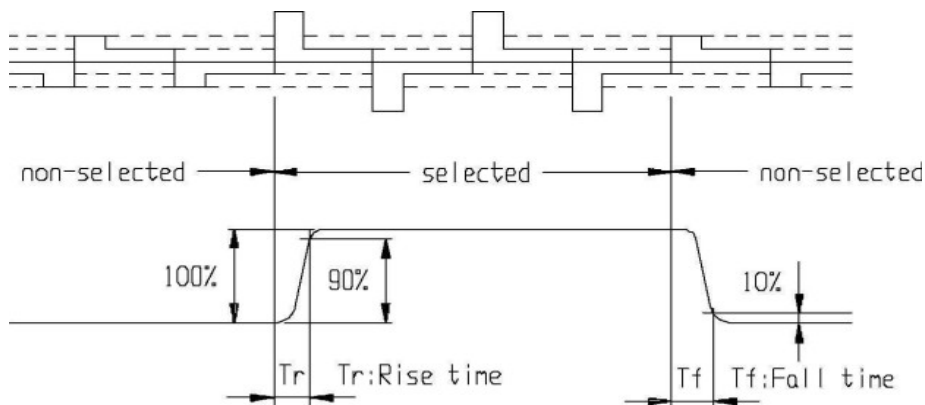

Note2 . Definition of Contrast Ratio 'Cr'

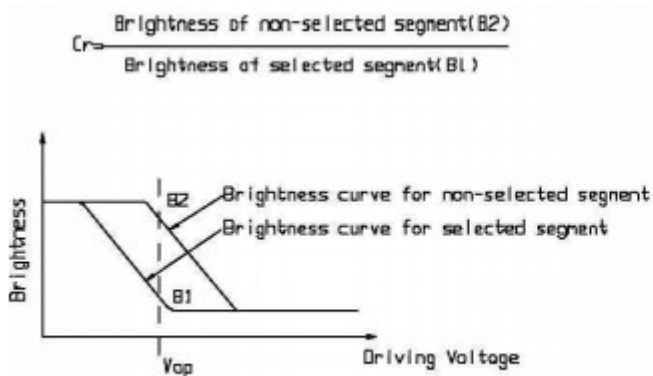

Note 3. Definition of Viewing Angle Range 'θ'

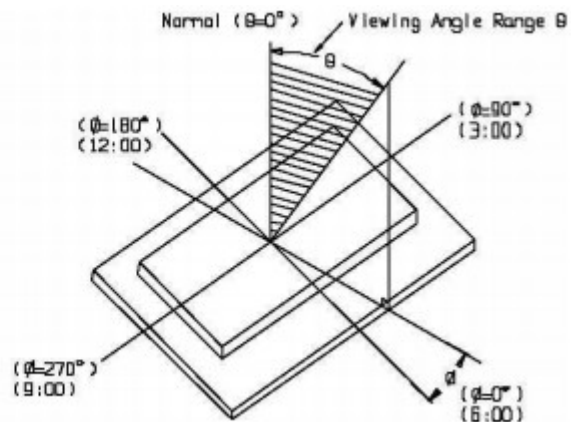



## 9. Control and display commands/指令描述

No.	Instrctions	Code												Function
		A0	/RD	/WR	D7	D6	D5	D4	D3	D2	D1	D0		
1	Display ON/OFF	0	1	0	1	0	1	0	1	1	1	1	DON	DON=0,display off DON=1,display on
2	Display start line set	0	1	0	0	1	Display start address						Set the display RAM display start line address	
3	Set Page Address	0	1	0	1	0	1	1	Page address					Set the display RAM Page address
4	Ser Column Address (Upper-4 bits)	0	1	0	0	0	0	1	Col. Add					Set the upper-4-bit of column address counter
	Ser Column Address (Lower-4 bits)	0	1	0	0	0	0	0	Col. Add					Set the low-4-bit of column address counter
5	Read Staus	0	0	1	Status				0	0	0	0		Read the status data
6	Write Display Data	1	1	0	Write Data									Write data into the display RAM
7	Read Display Data	1	0	1	Read Data									Read data from the display RAM
8	ADC Select	0	1	0	1	0	1	0	0	0	0	0	ADC	Set the display RAM address SEG output Correspondence ADC = 0,Normal. ADC = 1,Reverse
9	Normal/Reverse Display	0	1	0	1	0	1	0	0	1	1	REV	REV = 0, Normal REV = 1, Reverse	
10	Entire Display ON/OFF	0	1	0	1	0	1	0	0	1	0	EON	EON = 0, Normal EON = 1, Entire display ON	
11	Set LCD Bias	0	1	0	1	0	1	0	0	0	1	BIAS	Bias = 0, 1/9 Bias Bias = 1, 1/7 Bias	
12	Set Read-Modify-Write	0	1	0	1	1	1	0	0	0	0	0		Enter the "Read-Modify-Write" mode
13	Reset Read-Modify-Write	0	1	0	1	1	1	0	1	1	1	0		Clear the "Read-Modify-Write" mode
14	Reset	0	1	0	1	1	1	0	0	0	1	0		Resets the LCD module
15	SHL S elect	0	1	0	1	1	0	0	SHL	*	*	*		Set the COM scanning direction SHL = 0, Normal SHL = 1, Flipped in y-direction * = don't care terms
16	Power Control Set	0	1	0	0	0	1	0	1	VC	VR	VF		Set the power circuit operation mode VF : LCD Supply Voltage Follower VR : LCD Supply Voltage Regulator VF : LCD Supply Voltage Converter (1 = ON, 0 = OFF)
17	Regulator Resistor Select	0	1	0	0	0	1	0	0	Ratio				Set the built-in resistor ratio (Rb/Ra)
18	Electronic volume mode set	0	1	0	1	0	0	0	0	0	0	1		Set reference voltage mode
	Electronic volume register set	0	1	0	*	*	Electronic Control value						Set reference voltage register	
19	Power Save		-	-	-	-	-	-	-	-	-	-		Compound instruction Display OFF + Entire Display ON
20	NOP	0	1	0	1	1	1	0	0	0	1	1		Non-operation command

## 10. DDRAM 映射表

PA[3:0]	0	Line AddrCsa									Panel Location	MY=0		MY=1																																																																																								
												SL=0	SL=16	SL=0	SL=25	SL=25	SL=25																																																																																					
0000	D0	00H	0	1								COM1	C1	C49	C64	C48	C25	C9																																																																																				
	D1	01H	0	1								COM2	C2	C50	C63	C47	C24	C8																																																																																				
	D2	02H	0	0								COM3	C3	C51	C62	C46	C23	C7																																																																																				
	D3	03H	0	0								COM4	C4	C52	C61	C45	C22	C6																																																																																				
	D4	04H	0	1								COM5	C5	C53	C60	C44	C21	C5																																																																																				
	D5	05H	1	1								COM6	C6	C54	C59	C43	C20	C4																																																																																				
	D6	06H	1	0								COM7	C7	C55	C58	C42	C19	C3																																																																																				
	D7	07H	1	0								COM8	C8	C56	C57	C41	C18	C2																																																																																				
0001	D0	08H										COM9	C9	C57	C56	C40	C17	C1																																																																																				
	D1	09H										COM10	C10	C58	C55	C39	C16	--																																																																																				
	D2	0AH										COM11	C11	C59	C54	C38	C15	--																																																																																				
	D3	0BH										COM12	C12	C60	C53	C37	C14	--																																																																																				
	D4	0CH										COM13	C13	C61	C52	C36	C13	--																																																																																				
	D5	0DH										COM14	C14	C62	C51	C35	C12	--																																																																																				
	D6	0EH										COM15	C15	C63	C50	C34	C11	--																																																																																				
	D7	0FH										COM16	C16	C64	C49	C33	C10	--																																																																																				
0010	D0	10H										COM17	C17	C1	C48	C32	C9	--																																																																																				
	D1	11H										COM18	C18	C2	C47	C31	C8	--																																																																																				
	D2	12H										COM19	C19	C3	C46	C30	C7	--																																																																																				
	D3	13H										COM20	C20	C4	C45	C29	C6	--																																																																																				
	D4	14H										COM21	C21	C5	C44	C28	C5	--																																																																																				
	D5	15H										COM22	C22	C6	C43	C27	C4	--																																																																																				
	D6	16H										COM23	C23	C7	C42	C26	C3	--																																																																																				
	D7	17H										COM24	C24	C8	C41	C25	C2	--																																																																																				
0011	D0	18H										COM25	C25	C9	C40	C24	C1	--																																																																																				
	D1	19H										COM26	C26	C10	C39	C23	C64	C48*																																																																																				
	D2	1AH										COM27	C27	C11	C38	C22	C63	C47																																																																																				
	D3	1BH										COM28	C28	C12	C37	C21	C62	C46																																																																																				
	D4	1CH										COM29	C29	C13	C36	C20	C61	C45																																																																																				
	D5	1DH										COM30	C30	C14	C35	C19	C60	C44																																																																																				
	D6	1EH										COM31	C31	C15	C34	C18	C59	C43																																																																																				
	D7	1FH										COM32	C32	C16	C33	C17	C58	C42																																																																																				
0100	D0	20H										COM33	C33	C17	C32	C16	C57	C41																																																																																				
	D1	21H										COM34	C34	C18	C31	C15	C56	C40																																																																																				
	D2	22H										COM35	C35	C19	C30	C14	C55	C39																																																																																				
	D3	23H										COM36	C36	C20	C29	C13	C54	C38																																																																																				
	D4	24H										COM37	C37	C21	C28	C12	C53	C37																																																																																				
	D5	25H										COM38	C38	C22	C27	C11	C52	C36																																																																																				
	D6	26H										COM39	C39	C23	C26	C10	C51	C35																																																																																				
	D7	27H										COM40	C40	C24	C25	C9	C50	C34																																																																																				
0101	D0	28H										COM41	C41	C25	C24	C8	C49	C33																																																																																				
	D1	29H										COM42	C42	C26	C23	C7	C48	C32																																																																																				
	D2	2AH										COM43	C43	C27	C22	C6	C47	C31																																																																																				
	D3	2BH										COM44	C44	C28	C21	C5	C46	C30																																																																																				
	D4	2CH										COM45	C45	C29	C20	C4	C45	C29																																																																																				
	D5	2DH										COM46	C46	C30	C19	C3	C44	C28																																																																																				
	D6	2EH										COM47	C47	C31	C18	C2	C43	C27																																																																																				
	D7	2FH										COM48	C48	C32	C17	C1	C42	C26																																																																																				
0110	D0	30H										COM49	C49	C33	C16	--	C41	C25																																																																																				
	D1	31H										COM50	C50	C34	C15	--	C40	C24																																																																																				
	D2	32H										COM51	C51	C35	C14	--	C39	C23																																																																																				
	D3	33H										COM52	C52	C36	C13	--	C38	C22																																																																																				
	D4	34H										COM53	C53	C37	C12	--	C37	C21																																																																																				
	D5	35H										COM54	C54	C38	C11	--	C36	C20																																																																																				
	D6	36H										COM55	C55	C39	C10	--	C35	C19																																																																																				
	D7	37H										COM56	C56	C40	C9	--	C34	C18																																																																																				
0111	D0	38H										COM57	C57	C41	C8	--	C33	C17																																																																																				
	D1	39H										COM58	C58	C42	C7	--	C32	C16																																																																																				
	D2	3AH										COM59	C59	C43	C6	--	C31	C15																																																																																				
	D3	3BH										COM60	C60	C44	C5	--	C30	C14																																																																																				
	D4	3CH										COM61	C61	C45	C4	--	C29	C13																																																																																				
	D5	3DH										COM62	C62	C46	C3	--	C28	C12																																																																																				
	D6	3EH										COM63	C63	C47	C2	--	C27	C11																																																																																				
	D7	3FH										COM64	C64	C48	C1	--	C26	C10																																																																																				
1000	D0	40H										CIC	CIC	CIC	CIC	CIC	CIC																																																																																					
			<table border="1"> <thead> <tr> <th colspan="8">MX=0</th> <th colspan="8"></th> </tr> <tr> <th>SEG1</th><th>SEG2</th><th>SEG3</th><th>SEG4</th><th>SEG5</th><th>SEG6</th><th>SEG7</th><th>SEG8</th> <th>SEG9</th><th>SEG10</th><th>SEG11</th><th>SEG12</th> <th>SEG13</th><th>SEG14</th><th>SEG15</th><th>SEG16</th> <th>SEG17</th><th>SEG18</th><th>SEG19</th><th>SEG20</th> </tr> </thead> <tbody> <tr> <td></td><td></td><td></td><td></td><td></td><td></td><td></td><td></td> <td></td><td></td><td></td><td></td> <td></td><td></td><td></td><td></td> <td></td><td></td><td></td><td></td> </tr> <tr> <td></td><td></td><td></td><td></td><td></td><td></td><td></td><td></td> <td></td><td></td><td></td><td></td> <td></td><td></td><td></td><td></td> <td></td><td></td><td></td><td></td> </tr> </tbody> </table>								MX=0																SEG1	SEG2	SEG3	SEG4	SEG5	SEG6	SEG7	SEG8	SEG9	SEG10	SEG11	SEG12	SEG13	SEG14	SEG15	SEG16	SEG17	SEG18	SEG19	SEG20																																									<table border="1"> <thead> <tr> <th colspan="4">MUX</th> </tr> <tr> <th>65</th><th>49</th><th>65</th><th>49</th> </tr> </thead> <tbody> <tr> <td></td><td></td><td></td><td></td> </tr> </tbody> </table>				MUX				65	49	65	49				
MX=0																																																																																																						
SEG1	SEG2	SEG3	SEG4	SEG5	SEG6	SEG7	SEG8	SEG9	SEG10	SEG11	SEG12	SEG13	SEG14	SEG15	SEG16	SEG17	SEG18	SEG19	SEG20																																																																																			
MUX																																																																																																						
65	49	65	49																																																																																																			

Example for memory mapping: let MX = 0, MY = 0, SL = 0, according to the data shown in the above table:

- Page 0 SEG 1 (D7-D0) : 11100000b
- Page 0 SEG 2 (D7-D0) : 00110011b

## 12. Inspection Standards/检验标准

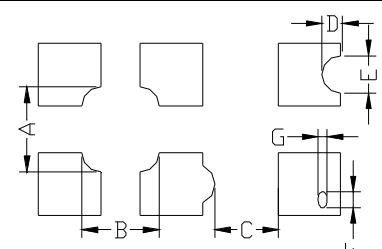
Item	Criterion for defects	Defect type
1) Display on inspection/显示效果	(1) Non display (2) Vertical line is deficient (3) Horizontal line is deficient (4) Cross line is deficient	Major
2) Black / White spot/黑点或白点	Size $\Phi$ (mm) Acceptable number $\Phi \leq 0.3$ Ignore (note) $0.3 < \Phi \leq 0.45$ 3 $0.45 < \Phi \leq 0.6$ 1 $0.6 < \Phi$ 0	Minor
3) Black / White line/黑线或白线	Length (mm) Width (mm) Acceptable number $L \leq 10$ $W \leq 0.03$ Ignore $5.0 \leq L \leq 10$ $0.03 < W \leq 0.04$ 3 $5.0 \leq L \leq 10$ $0.04 < W \leq 0.05$ 2 $1.0 \leq L \leq 10$ $0.05 < W \leq 0.06$ 2 $1.0 \leq L \leq 10$ $0.06 < W \leq 0.08$ 1 $L \leq 10$ $0.08 < W$ follows 2) point defect Defects separate with each other at an interval of more than 20mm	Minor
4) Display pattern/显示模式	 $\frac{A+B \leq 0.28}{2}$ $0 < C$ $\frac{D+E \leq 0.25}{2}$ $\frac{F+G \leq 0.25}{2}$ Note: 1) Up to 3 damages acceptable 2) Not allowed if there are two or more pinholes every three-fourth inch.	Minor
5) Spot-like contrast irregularity/均匀度	Size $\Phi$ (mm) Acceptable Number $\Phi \leq 0.7$ Ignore (note) $0.7 < \Phi \leq 1.0$ 3 $1.0 < \Phi \leq 1.5$ 1 $1.5 < \Phi$ 0 Note: 1) Conformed to limit samples. 2) Intervals of defects are more than 30mm.	Minor
6) Bubbles in polarizer/玻璃内有气泡	Size $\Phi$ (mm) Acceptable Number $\Phi \leq 0.4$ Ignore (note) $0.4 < \Phi \leq 0.65$ 2 $0.65 < \Phi \leq 1.2$ 1 $1.2 < \Phi$ 0	Minor
7) Scratches and dent on the polarizer/玻璃刮痕/凹痕	Scratches and dent on the polarizer shall be in the accordance with "2) Black/white spot", and "3) Black/White line".	Minor
8) Stains on the surface of LCD panel/玻璃上有污点	Stains which cannot be removed even when wiped lightly with a soft cloth or similar cleaning.	Minor
9) Rainbow color/杂色	No rainbow color is allowed in the optimum contrast on state within the active area.	Minor
10) Viewing-area encroachment/玻璃边线出现在视域	Polarizer edge or line is visible in the opening viewing area due to polarizer shortness or sealing line.	Minor
11) Bezel appearance/铁筐外观	Rust and deep damages that are visible in the bezel are rejected.	Minor
12) Defect of land surface 表面缺陷	Evident crevices that are visible are rejected.	Minor
13) Parts mounting/部件安装	(1) Failure to mount parts (2) Parts not in the specifications are mounted (3) For example: Polarity is reversed, HSC or TCP falls off.	Minor
14) Part alignment/部件结合度	(1) LSI, IC lead width is more than 50% beyond pad outline. (2) More than 50% of LSI, IC leads is off the pad outline.	Minor
15) Conductive foreign matter (solder ball, solder hips)/杂质 (焊接遗留物)	(1) $0.45 < \Phi$ , $N \geq 1$ (2) $0.3 < \Phi \leq 0.45$ , $N \geq 1$ , $\Phi$ : Average diameter of solder ball (unit: mm) (3) $0.5 < L$ , $N \geq 1$ , L: Average length of solder chip (unit: mm)	Minor
16) Bezel flaw/铁筐缺陷	Bezel claw missing or not bent	Minor
17) Indication on name plate (sampling indication label)/标志	(1) Failure to stamp or label error, or not legible.(all acceptable if legible) (2) The separation is more than 1/3 for indication discoloration, in which the characters can be checked.	Minor

## 12. Handling precautions 注意事项

1. Refrain from strong mechanical shock and forces to the module. It may cause improper operating or damage to the module.  
防止震动和压迫模组，以免造成模组损坏和运行正常。
2. The polarizer used on the display surface is easily scratched and damaged. Extreme care should be taken when handling. When cleaning the display surface, use soft cloth with a solvent recommended : ethyl alcohol , isopropyl or hexane) and wipe gently, do not use the following solvents : water, ketone or aromatics .  
模组表面的偏光极易被刮伤和损坏，所以操作是要非常小心。请用蘸有乙醇，丙酮等溶剂的湿软布轻轻擦拭，不要使用水，乙酮等溶剂。
3. Wipe off water or oil drop immediately If you leave drop for a long time, stain and discoloration may occur.  
要立即擦拭掉屏幕上的油滴和水滴，否则会出现污点和杂质。
4. Do not touch pads or pins of interface directly with bare hands. When handling the LCD module, put on a soft glover like finger-glover.  
不要直接用手去触碰接口处的金属管脚。当操作模组的时候，请配带软指套。
5. Protect the module from static electricity, it may cause damage to CMOS LSI.  
模组需要有防静电保护，否则会损坏CMOS LSI。
6. To prevent LCD panels from degradation, do not operate or store them exposed directly to sunlight or high temperature/humidity.  
不要直接在太阳,高温或潮湿环境下操作和储存LCD模组，以免影响模组的质量。
7. If the liquid crystal leaks from the panel it should be kept away from the eyes and mouths. In case of contact with skins, wash away thoroughly with soap and water.  
若有液晶漏出，务必避免其入眼入口。若沾到皮肤上了，马上用肥皂和水冲洗干净。
8. Soldering should be only performed on the I/O terminals within the temperature of  $280 \pm 20^{\circ}\text{C}$  and soldering time should be less than 4 seconds.  
要在 $280 \pm 20^{\circ}\text{C}$ 的条件下在I/O终端实现焊接，并且保证焊接时间短于4秒。
9. Supply voltage within the specified voltage limit, the maximum rating, higher voltage cause the shorter LCD life or damaged.  
绝对要在指定的电压范围内驱动模组， 因为如果在高于指定电压的情况下驱动模组，会使模组寿命变短
10. Do not input any signals before power is turned on. Do not connect or disconnect the module on the state of Power-ON.  
供电之前不要输入任何信号，不要在通电时连接和段开 LCD 模组。