

# LCD&LCM SPECIFICATION

## 液晶显示屏产品使用说明书

MODULE NO.

—12864TM545A—

128x64 图形点阵

COG+PCB 工艺

8 位并口或 SPI 串口通讯

Designed	Checked	Approved

**Revision history 修改记录**

revision	date	description	remark
A00	2013-05-16	First release	



## Content/目录

1. **Feature/显示特性**
2. **Mechanical specifications/外形尺寸说明**
3. **Pin description/PIN 脚描述**
4. **Absolute maximum rating/限定参数**
5. **Electrical characteristics/电气特性**
6. **Backlight characteristics/背光特性**
7. **Electrical-optical characteristics/光学特性**
8. **Control and display commands/指令描述**
9. **DDRAM 映射表**
10. **Inspection standards/检验标准**
11. **Handling precautions/注意事项**

## 1. Feature/显示特性

- Display resolution/点阵数 : 128(w)\*64(h)
- Display mode/显示模式 : FSTN ,Positive(or Negative), Transmissive
- Driving method/驱动方式 : 1/64 Duty , 1/9 Bias
- Viewing direction/视角 : 6:00 o'clock
- Backlight/背光 : LED , White(or Green,Blue,Other)
- Built-in controller/控制器 : ST7565R
- Operation temp/工作温度 : -20°C~70°C
- Storage temp/储存温度 : -30°C~80°C

## 2. Mechanical Specifications/外形尺寸说明

### 2.1 尺寸描述

- Dimensional outline (W\*H\*T)/外形尺寸 : 54.0mm\*50.0mm\*7.0mm
- Viewing area (W\*H)/视域尺寸 : 44.0mm\*29.0mm
- Dot pitch (W\*H)/点距 : 0.31mm\*0.39mm
- Dot size (W\*H)/点大小 : 0.29mm\*0.36mm

### 2.2 Outline Dimension 外形尺寸图

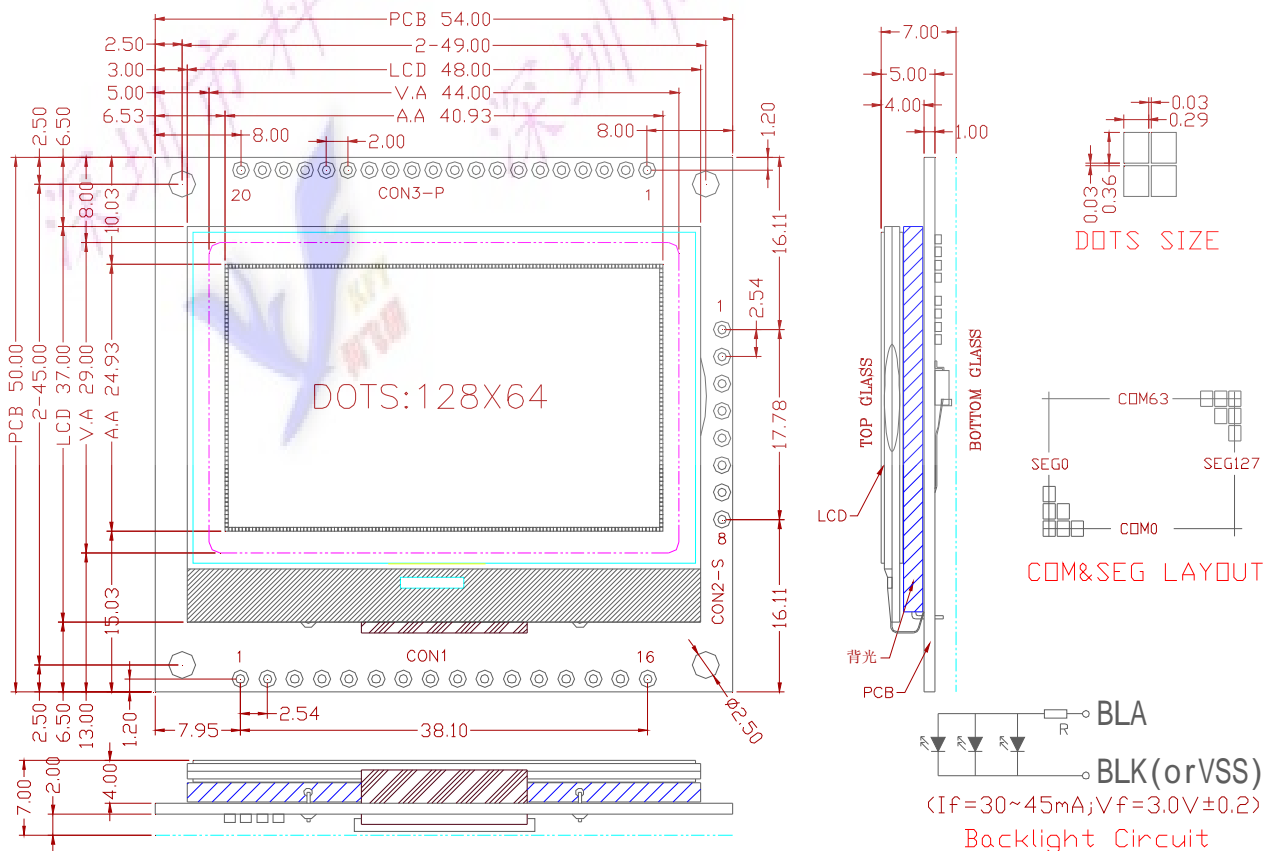

### 3. Pin description/PIN 脚描述

CON1 (8 位并口)			
Pin No.	Pin Name	Function	
1	RD	Read (/RD ) control signal input.	读
2	WR	Write (WR ) control signal input.	写
3	A0 (RS)	Data/Command control	选择指令或数据
4	/RES	Rester	复位
5	/CS1	Chip selection input	片选
6	BLA	Backlight Positive Power (3.3V or 5.0V )	背光电源正极 3.3V 或 5.0V
7	VSS	Negative power supply,0V	地
8	VDD	Power supply voltage (Positive)	电源 3.3V 或 5.0V
9	D7 (SDA)	8 Bit Date bus	数据
10	D6 (SCLK)		
11	D5		
12	D4		
13	D3		
14	D2		
15	D1		
16	D0		

CON2-S (SPI 串口)			
Pin No.	Pin Name	Function	
1	VSS	Negative power supply,0V	地
2	VDD	Power supply voltage (Positive)	电源 3.3V 或 5.0V
3	SDA	(D7) Serial data input	SPI 数据
4	SCLK	(D6) The serial clock input	SPI 串口时钟
5	A0	Data/Command control	选择指令或数据
6	/RES	Rester	复位
7	/CS1	Chip selection input	片选
8	BLA	Backlight Positive Power (3.3V or 5.0V )	背光电源正极 3.3V 或 5.0V

CON3-P (8 位并口)		
Pin No.	Pin Name	Function
1	VSS	Negative power supply,0V 地
2	VDD	Power supply voltage (Positive) 电源 3.3V 或 5.0V
3	NC (P/S)	空脚 (或并/串选择脚)
4	A0 (RS)	Data/Command control 选择指令或数据
5	WR	Write (/WR ) control signal input. 写
6	RD	Read (/RD ) control signal input. 读
7	D0	8 Bit Date bus 数据
8	D1	
9	D2	
10	D3	
11	D4	
12	D5	
13	D6	
14	D7	
15	NC (C86)	空脚 (或时序选择脚)
16	/CS1	Chip selection input 片选
17	/RES	Rester 复位
18	NC (VOUT)	空脚 (或外部供电)
19	BLK	Backlight Negative Power (0V) 背光电源负极 0V
20	BLA	Backlight Positive Power (3.3V or 5.0V ) 背光电源正极 3.3V 或 5.0V



5.2.2 . 6800 Mode System Bus Timing (6800 并口时序图)

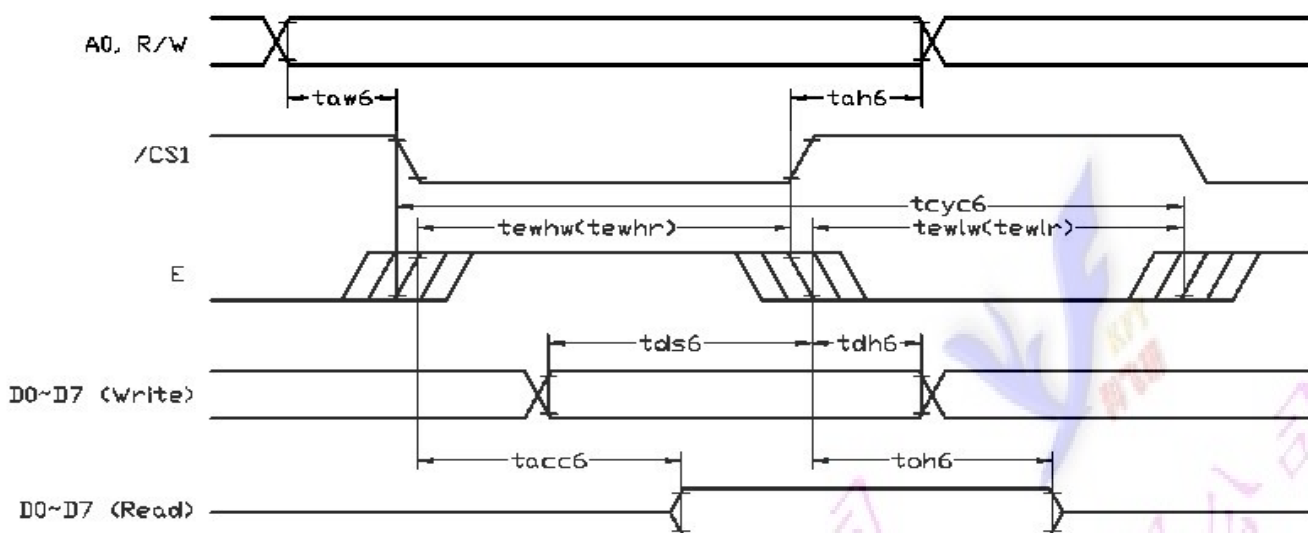

5.2.3 四线 SPI 串口时序图

The 4-line SPI Interface

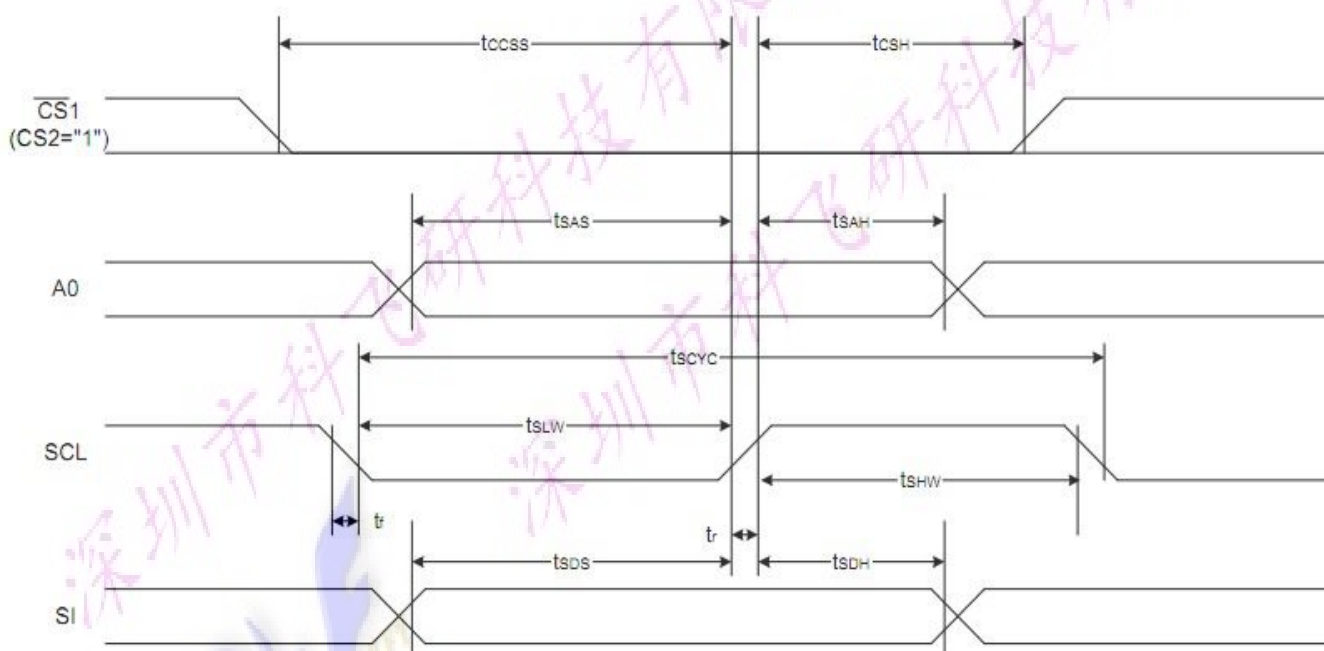

Item	Signal	Symbol	Condition	Rating		Units
				Min.	Max.	
4-line SPI Clock Period	SCL	T <sub>scyc</sub>		100	—	ns
SCL "H" pulse width		T <sub>shw</sub>		50	—	
SCL "L" pulse width		T <sub>slw</sub>		50	—	
Address setup time	A0	T <sub>sas</sub>		30	—	
Address hold time		T <sub>сах</sub>		20	—	
Data setup time	SI	T <sub>sdс</sub>		30	—	
Data hold time		T <sub>sdh</sub>		20	—	
CS-SCL time	CS	T <sub>ссs</sub>		30	—	
CS-SCL time		T <sub>сsh</sub>		60	—	



### 5.2.4 Reset timing (复位)

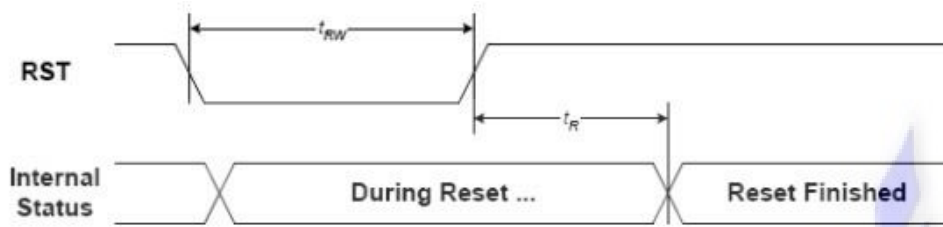

FIGURE 15: Reset Characteristics

( $1.65V \leq V_{DD} < 3.3V$ ,  $T_a = -30$  to  $+85^\circ C$ )

Symbol	Signal	Description	Condition	Min.	Max.	Units
$t_{RW}$	RST	Reset low pulse width		3	-	$\mu S$
$t_R$	RST,, Internal Status	Reset to Internal Status pulse delay		6	-	mS

## 6. Backlight Characteristics/背光特性

Items	Symbol	MIN.	TYP.	MAX.	Unit	Condition
Forward Voltage/电压	Vf	2.8	3.0	3.1	V	If=30mA
Reverse current/电流	Ir	---	30	40	mA	Vr=3V
Peak wave length/波长	$\lambda$	---	---	---	nM	If=30mA
Luminance/亮度	Lv	---	---	---	Cd/m <sup>2</sup>	If=30mA
Color /颜色	White (白色, 或者其他色)					

## 7. Electrical-Optical Characteristics/光学特性

Items	Symbol	Condition	MIN.	TYP.	MAX.	Unit	NOTE
Response time/反应时间	Tr	Ta= 25°C	---	185	---	ms	2
	Tf		---	200	---		
Contrast ratio/对比度	Cr	Ta= 25°C	---	--	---		3
Viewing angle range/视角范围	$\theta$	Cr $\geq$ 2	-40	---	40	degree	

Note 1. Definition of response time

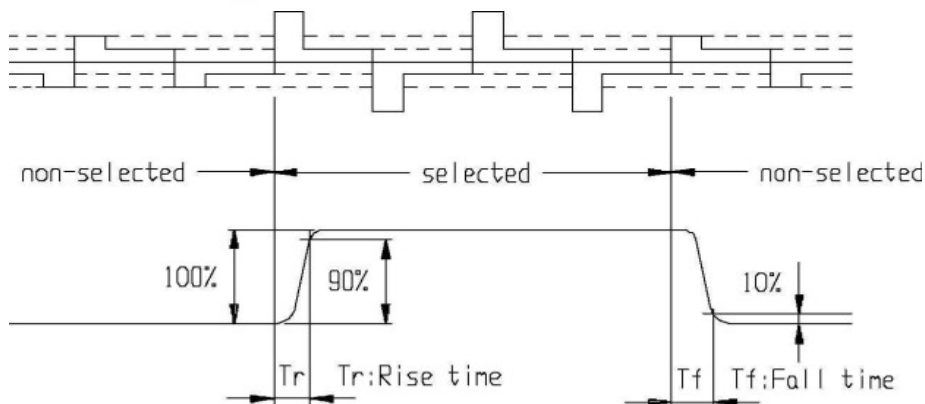

Note2 . Definition of Contrast Ratio‘Cr’

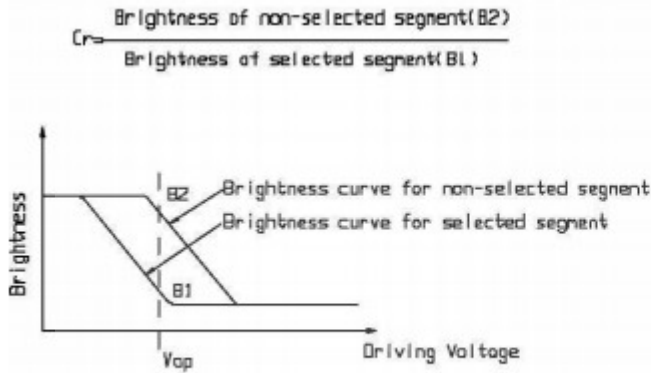

Note 3. Definition of Viewing Angle Range ‘ $\theta$ ’

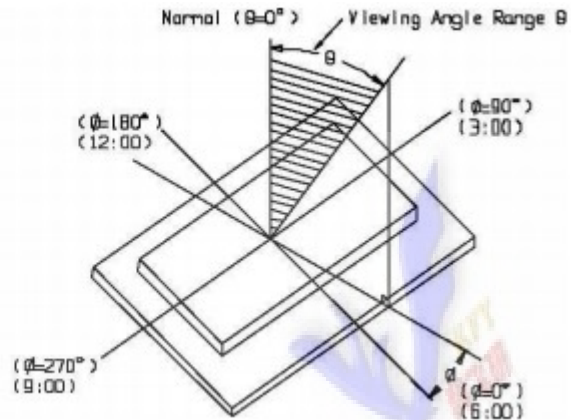

### 8. Control and display commands/指令描述

No.	Instrctions	Code												Function	
		A0	/RD	/WR	D7	D6	D5	D4	D3	D2	D1	D0			
1	Display ON/OFF	0	1	0	1	0	1	0	1	1	1	1	DON	DON=0,display off DON=1,display on	
2	Display start line set	0	1	0	0	1	Display start address						Set the display RAM display start line address		
3	Set Page Address	0	1	0	1	0	1	1	Page address					Set the display RAM Page address	
4	Ser Column Address (Upper-4 bits)	0	1	0	0	0	0	1	Col. Add					Set the upper-4-bit of column address counter	
	Ser Column Address (Lower-4 bits)	0	1	0	0	0	0	0	Col. Add					Set the low-4-bit of column address counter	
5	Read Staus	0	0	1	Status				0	0	0	0		Read the status data	
6	Write Display Data	1	1	0	Write Data									Write data into the display RAM	
7	Read Display Data	1	0	1	Read Data									Read data from the display RAM	
8	ADC Select	0	1	0	1	0	1	0	0	0	0	0	ADC	Set the display RAM address SEG output Correspondence ADC = 0,Normal. ADC = 1,Reverse	
9	Normal/Reverse Display	0	1	0	1	0	1	0	0	1	1		REV	REV = 0, Normal REV = 1, Reverse	
10	Entire Display ON/OFF	0	1	0	1	0	1	0	0	1	0		EON	EON = 0, Normal EON = 1, Entire display ON	
11	Set LCD Bias	0	1	0	1	0	1	0	0	0	1		BIAS	Bias = 0, 1/9 Bias Bias = 1, 1/7 Bias	
12	Set Read-Modify-Write	0	1	0	1	1	1	0	0	0	0	0			Enter the “Read-Modify-Write” mode
13	Reset Read-Modify-Write	0	1	0	1	1	1	0	1	1	1	0			Clear the “Read-Modify-Write” mode
14	Reset	0	1	0	1	1	1	0	0	0	1	0			Resets the LCD module
15	SHL S elect	0	1	0	1	1	0	0	SHL	*	*	*			Set the COM scanning direction SHL = 0, Normal SHL = 1, Flipped in y-direction * = don't care terms
16	Power Control Set	0	1	0	0	0	1	0	1	VC	VR	VF			Set the power circuit operation mode VF : LCD Supply Voltage Follower VR : LCD Supply Voltage Regulator VF : LCD Supply Voltage Converter (1 = ON, 0 = OFF)

17	Regulator Resistor Select	0	1	0	0	0	1	0	0	Ratio	Set the built-in resistor ratio (Rb/Ra)		
18	Electronic volume mode set	0	1	0	1	0	0	0	0	0	1	Set reference voltage mode	
	Electronic volume register set	0	1	0	*	*	Electronic Control value				Set reference voltage register		
19	Power Save		-	-	-	-	-	-	-	-	Compound instruction Display OFF + Entire Display ON		
20	NOP	0	1	0	1	1	1	0	0	0	1	1	Non-operation command

### 9. DDRAM 映射表

PA[3:0]	Line AddeCsa	0	1	MY=0		MY=1		Panel Location	SL=0		SL=16		SL=25		SL=25	
				SL=0	SL=16	SL=0	SL=16		SL=0	SL=16	SL=0	SL=25	SL=0	SL=25		
0000	D0	00H	0	1				COM1	C1	C49	C64	C48	C25	C9		
	D1	01H	0	1				COM2	C2	C50	C63	C47	C24	C8		
	D2	02H	0	0				COM3	C3	C51	C62	C46	C23	C7		
	D3	03H	0	0				COM4	C4	C52	C61	C45	C22	C6		
	D4	04H	0	1				COM5	C5	C53	C60	C44	C21	C5		
	D5	05H	1	1				COM6	C6	C54	C59	C43	C20	C4		
	D6	06H	1	0				COM7	C7	C55	C58	C42	C19	C3		
	D7	07H	1	0				COM8	C8	C56	C57	C41	C18	C2		
0001	D0	08H						COM9	C9	C57	C56	C40	C17	C1		
	D1	09H						COM10	C10	C58	C55	C39	C16	--		
	D2	0AH						COM11	C11	C59	C54	C38	C15	--		
	D3	0BH						COM12	C12	C60	C53	C37	C14	--		
	D4	0CH						COM13	C13	C61	C52	C36	C13	--		
	D5	0DH						COM14	C14	C62	C51	C35	C12	--		
	D6	0EH						COM15	C15	C63	C50	C34	C11	--		
	D7	0FH						COM16	C16	C64	C49	C33	C10	--		
0010	D0	10H						COM17	C17	C1	C48	C32	C9	--		
	D1	11H						COM18	C18	C2	C47	C31	C8	--		
	D2	12H						COM19	C19	C3	C46	C30	C7	--		
	D3	13H						COM20	C20	C4	C45	C29	C6	--		
	D4	14H						COM21	C21	C5	C44	C28	C5	--		
	D5	15H						COM22	C22	C6	C43	C27	C4	--		
	D6	16H						COM23	C23	C7	C42	C26	C3	--		
	D7	17H						COM24	C24	C8	C41	C25	C2	--		
0011	D0	18H						COM25	C25	C9	C40	C24	C1	--		
	D1	19H						COM26	C26	C10	C39	C23	C64	C48*		
	D2	1AH						COM27	C27	C11	C38	C22	C63	C47		
	D3	1BH						COM28	C28	C12	C37	C21	C62	C46		
	D4	1CH						COM29	C29	C13	C36	C20	C61	C45		
	D5	1DH						COM30	C30	C14	C35	C19	C60	C44		
	D6	1EH						COM31	C31	C15	C34	C18	C59	C43		
	D7	1FH						COM32	C32	C16	C33	C17	C58	C42		
0100	D0	20H						COM33	C33	C17	C32	C16	C57	C41		
	D1	21H						COM34	C34	C18	C31	C15	C56	C40		
	D2	22H						COM35	C35	C19	C30	C14	C55	C39		
	D3	23H						COM36	C36	C20	C29	C13	C54	C38		
	D4	24H						COM37	C37	C21	C28	C12	C53	C37		
	D5	25H						COM38	C38	C22	C27	C11	C52	C36		
	D6	26H						COM39	C39	C23	C26	C10	C51	C35		
	D7	27H						COM40	C40	C24	C25	C9	C50	C34		
0101	D0	28H						COM41	C41	C25	C24	C8	C49	C33		
	D1	29H						COM42	C42	C26	C23	C7	C48	C32		
	D2	2AH						COM43	C43	C27	C22	C6	C47	C31		
	D3	2BH						COM44	C44	C28	C21	C5	C46	C30		
	D4	2CH						COM45	C45	C29	C20	C4	C45	C29		
	D5	2DH						COM46	C46	C30	C19	C3	C44	C28		
	D6	2EH						COM47	C47	C31	C18	C2	C43	C27		
	D7	2FH						COM48	C48	C32	C17	C1	C42	C26		
0110	D0	30H						COM49	C49	C33	C16	--	C41	C25		
	D1	31H						COM50	C50	C34	C15	--	C40	C24		
	D2	32H						COM51	C51	C35	C14	--	C39	C23		
	D3	33H						COM52	C52	C36	C13	--	C38	C22		
	D4	34H						COM53	C53	C37	C12	--	C37	C21		
	D5	35H						COM54	C54	C38	C11	--	C36	C20		
	D6	36H						COM55	C55	C39	C10	--	C35	C19		
	D7	37H						COM56	C56	C40	C9	--	C34	C18		
0111	D0	38H						COM57	C57	C41	C8	--	C33	C17		
	D1	39H						COM58	C58	C42	C7	--	C32	C16		
	D2	3AH						COM59	C59	C43	C6	--	C31	C15		
	D3	3BH						COM60	C60	C44	C5	--	C30	C14		
	D4	3CH						COM61	C61	C45	C4	--	C29	C13		
	D5	3DH						COM62	C62	C46	C3	--	C28	C12		
	D6	3EH						COM63	C63	C47	C2	--	C27	C11		
	D7	3FH						COM64	C64	C48	C1	--	C26	C10		
1000	D0	40H						CIC	CIC	CIC	CIC	CIC	CIC			

Example for memory mapping: let MX = 0, MY = 0, SL = 0, according to the data shown in the above table:

- Page 0 SEG 1 (D7-D0) : 11100000b
- Page 0 SEG 2 (D7-D0) : 00110011b

## 10. Inspection Standards/检验标准

Item	Criterion for defects	Defect type
1) Display on inspection/显示效果	(1) Non display (2) Vertical line is deficient (3) Horizontal line is deficient (4) Cross line is deficient	Major
2) Black / White spot/黑点或白点	Size $\Phi$ (mm) Acceptable number $\Phi \leq 0.3$ Ignore (note) $0.3 < \Phi \leq 0.45$ 3 $0.45 < \Phi \leq 0.6$ 1 $0.6 < \Phi$ 0	Minor
3) Black / White line/黑线或白线	Length (mm) Width (mm) Acceptable number $L \leq 10$ $W \leq 0.03$ Ignore $5.0 \leq L \leq 10$ $0.03 < W \leq 0.04$ 3 $5.0 \leq L \leq 10$ $0.04 < W \leq 0.05$ 2 $1.0 \leq L \leq 10$ $0.05 < W \leq 0.06$ 2 $1.0 \leq L \leq 10$ $0.06 < W \leq 0.08$ 1 $L \leq 10$ $0.08 < W$ follows 2) point defect Defects separate with each other at an interval of more than 20mm	Minor
4) Display pattern/显示模式	 <p style="text-align: center;"> <math>\frac{A+B \leq 0.28}{2}</math>    <math>0 &lt; C</math>    <math>\frac{D+E \leq 0.25}{2}</math>    <math>\frac{F+G \leq 0.25}{2}</math> </p> <p>Note: 1) Up to 3 damages acceptable  2) Not allowed if there are two or more pinholes every three-fourth inch.</p>	Minor
5) Spot-like contrast irregularity/均匀度	Size $\Phi$ (mm) Acceptable Number $\Phi \leq 0.7$ Ignore (note) $0.7 < \Phi \leq 1.0$ 3 $1.0 < \Phi \leq 1.5$ 1 $1.5 < \Phi$ 0 Note: 1) Conformed to limit samples. 2) Intervals of defects are more than 30mm.	Minor
6) Bubbles in polarizer/玻璃内有气泡	Size $\Phi$ (mm) Acceptable Number $\Phi \leq 0.4$ Ignore (note) $0.4 < \Phi \leq 0.65$ 2 $0.65 < \Phi \leq 1.2$ 1 $1.2 < \Phi$ 0	Minor
7) Scratches and dent on the polarizer/玻璃刮痕/凹痕	Scratches and dent on the polarizer shall be in the accordance with "2) Black/white spot", and "3) Black/White line".	Minor
8) Stains on the surface of LCD panel/玻璃上有污点	Stains which cannot be removed even when wiped lightly with a soft cloth or similar cleaning.	Minor
9) Rainbow color/杂色	No rainbow color is allowed in the optimum contrast on state within the active area.	Minor
10) Viewing-area encroachment/玻璃边线出现在视域	Polarizer edge or line is visible in the opening viewing area due to polarizer shortness or sealing line.	Minor
11) Bezel appearance/铁筐外观	Rust and deep damages that are visible in the bezel are rejected.	Minor
12) Defect of land surface 表面缺陷	Evident crevices that are visible are rejected.	Minor
13) Parts mounting/部件安装	(1) Failure to mount parts (2) Parts not in the specifications are mounted (3) For example: Polarity is reversed, HSC or TCP falls off.	Minor
14) Part alignment/部件结合度	(1) LSI, IC lead width is more than 50% beyond pad outline. (2) More than 50% of LSI, IC leads is off the pad outline.	Minor
15) Conductive foreign matter (solder ball, solder hips)/杂质 (焊接遗留物)	(1) $0.45 < \Phi$ , $N \geq 1$ (2) $0.3 < \Phi \leq 0.45$ , $N \geq 1$ , $\Phi$ : Average diameter of solder ball (unit: mm) (3) $0.5 < L$ , $N \geq 1$ , L: Average length of solder chip (unit: mm)	Minor
16) Bezel flaw/铁筐破裂	Bezel claw missing or not bent	Minor
17) Indication on name plate (sampling indication label)/标志	(1) Failure to stamp or label error, or not legible.(all acceptable if legible) (2) The separation is more than 1/3 for indication discoloration, in which the characters can be checked.	Minor

## 11. Handling precautions 注意事项

1. Refrain from strong mechanical shock and forces to the module. It may cause improper operating or damage to the module.  
防止震动和压迫模组，以免造成模组损坏和运行正常。
2. The polarizer used on the display surface is easily scratched and damaged. Extreme care should be taken when handling. When cleaning the display surface, use soft cloth with a solvent recommended : ethyl alcohol , isopropyl or hexane) and wipe gently, do not use the following solvents : water, ketone or aromatics .  
模组表面的偏光极易被刮伤和损坏，所以操作是要非常小心。请用蘸有乙醇，丙酮等溶剂的湿软布轻轻擦拭，不要使用水，乙酮等溶剂。
3. Wipe off water or oil drop immediately If you leave drop for a long time, stain and discoloration may occur.  
要立即擦拭掉屏幕上的油滴和水滴，否则会出现污点和杂质。
4. Do not touch pads or pins of interface directly with bare hands. When handling the LCD module, put on a soft glover like finger-glover.  
不要直接用手去触碰接口处的金属管脚。当操作模组的时候，请配带软指套。
5. Protect the module from static electricity, it may cause damage to CMOS LSI.  
模组需要有防静电保护，否则会损坏CMOS LSI。
6. To prevent LCD panels from degradation, do not operate or store them exposed directly to sunlight or high temperature/humidity.  
不要直接在太阳,高温或潮湿环境下操作和储存LCD模组，以免影响模组的质量。
7. If the liquid crystal leaks from the panel it should be kept away from the eyes and mouths. In case of contact with skins, wash away thoroughly with soap and water.  
若有液晶漏出，务必避免其入眼入口。若沾到皮肤上了，马上用肥皂和水冲洗干净。
8. Soldering should be only performed on the I/O terminals within the temperature of  $280 \pm 20^{\circ}\text{C}$  and soldering time should be less than 4 seconds.  
要在 $280 \pm 20^{\circ}\text{C}$ 的条件下在I/O终端实现焊接，并且保证焊接时间短于4秒。
9. Supply voltage within the specified voltage limit, the maximum rating, higher voltage cause the shorter LCD life or damaged.  
绝对要在指定的电压范围内驱动模组， 因为如果在高于指定电压的情况下驱动模组，会使模组寿命变短
10. Do not input any signals before power is turned on. Do not connect or disconnect the module on the state of Power-ON.  
供电之前不要输入任何信号，不要在通电时连接和段开 LCD 模组。