

LCD&LCM
SPECIFICATION

液晶显示屏产品使用说明书

MODULE NO.

————T12864C048A————

128x64 图形点阵

COG 工艺

Designed	Checked	Approved

Revision history 修改记录

revision	date	description	remark
A00	2013-03-28	First release	

Content/目录

1. **Feature/显示特性**
2. **Mechanical specifications/外形尺寸说明**
3. **Block diagram & power supply/电路原理图**
4. **Pin description/PIN 脚描述**
5. **Absolute maximum rating/限定参数**
6. **Electrical characteristics/电气特性**
7. **Backlight characteristics/背光特性**
8. **Electrical-optical characteristics/光学特性**
9. **Control and display commands/指令描述**
10. **DDRAM 映射表**
11. **Inspection standards/检验标准**
12. **Handling precautions/注意事项**

1. Feature/显示特性

- Display resolution/点阵数 : 128(w)*64(h)
- Display mode/显示模式 : FSTN ,Positive, Transflective
- Driving method/驱动方式 : 1/64 Duty , 1/9 Bias
- Viewing direction/视角 : 6:00 o'clock
- Backlight/背光 : LED , White(or Green,Blue,Other)
- Built-in controller/控制器 : ST7565R
- Operation temp/工作温度 : -20°C~70°C
- Storage temp/储存温度 : -30°C~80°C

2. Mechanical Specifications/外形尺寸说明

2.1 尺寸描述

- Dimensional outline (W*H*T)/外形尺寸 : 48.0mm*37.0mm*4.0mm
- Viewing area (W*H)/视域尺寸 : 44.0mm*29.0mm
- Dot pitch (W*H)/点距 : 0.32mm*0.39mm
- Dot size (W*H)/点大小 : 0.29mm*0.36mm

2.2 Outline Dimension 外形尺寸图

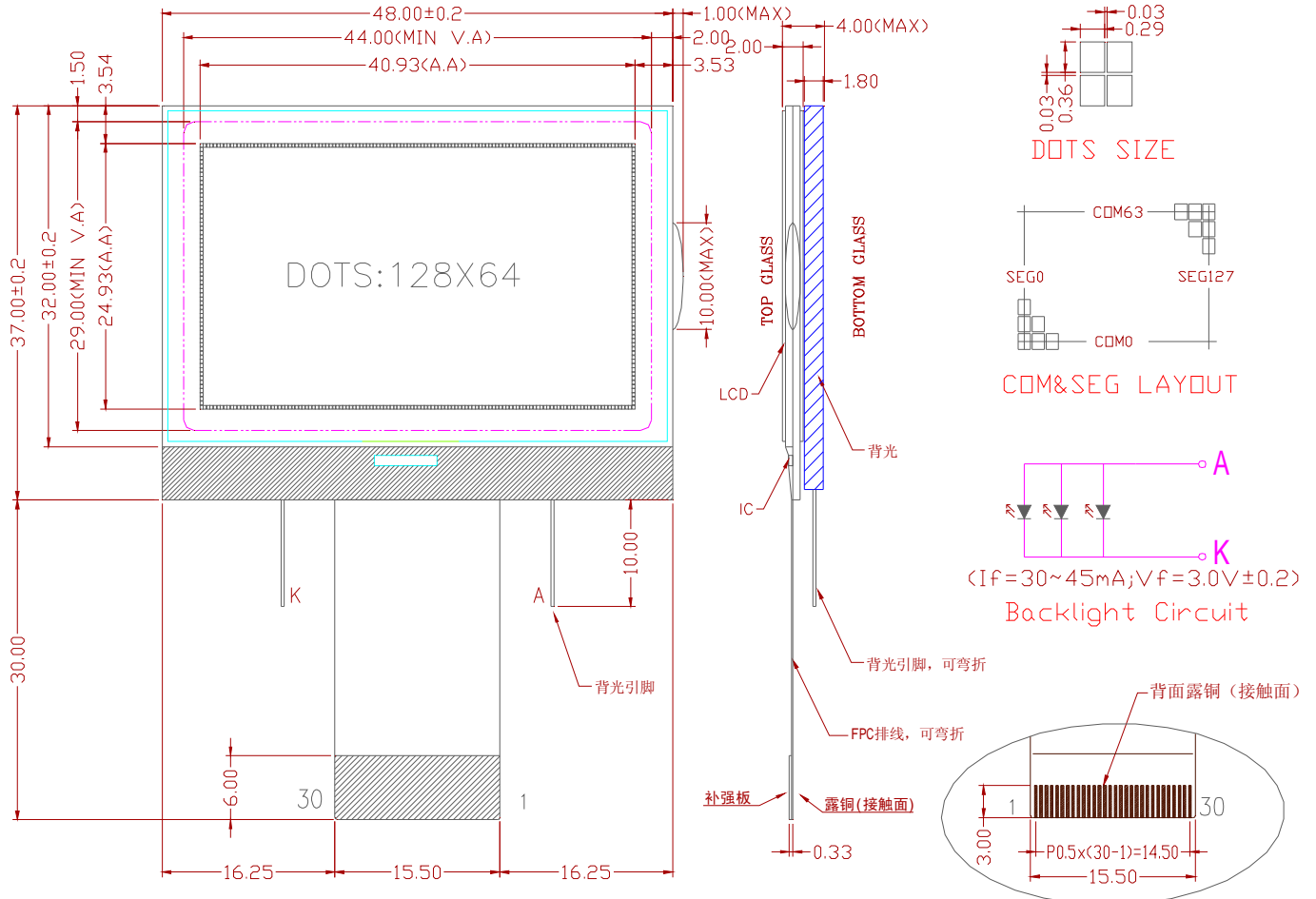

3.Block Diagram & Power supply/电路原理图

8位并口参考图



SPI串口参考图

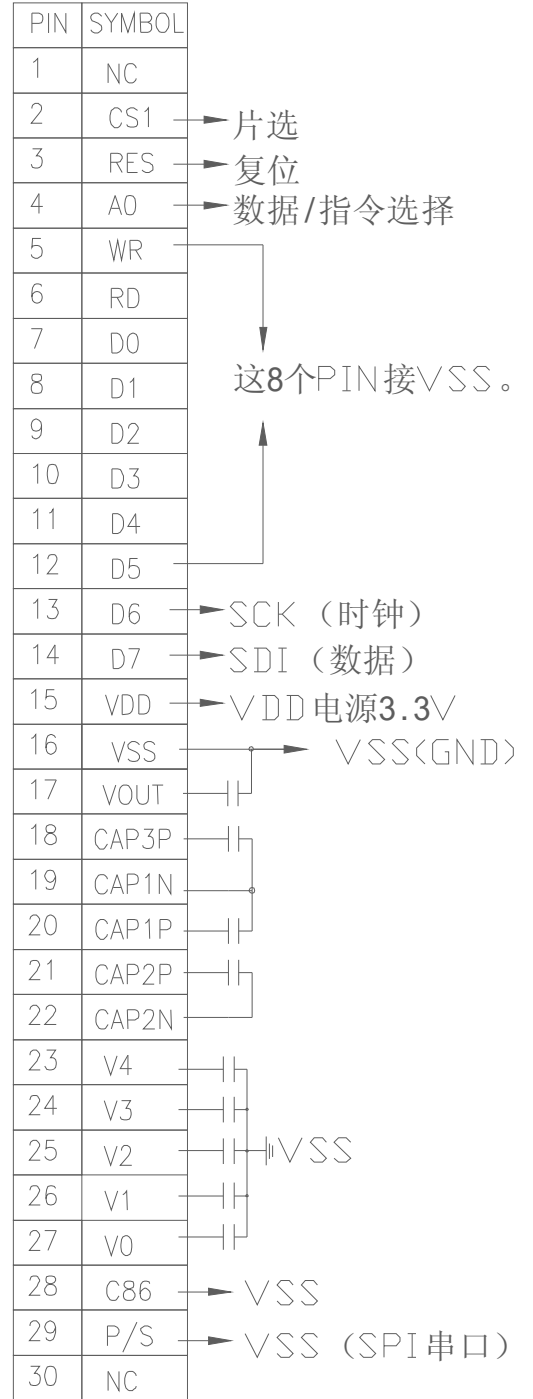

以上电容均采用无极性电容，容值1uF/25V。

4. Pin description/PIN 脚描述

Pin No.	Pin Name	Function
1	NC	空脚
2	/CS1	Chip selection input 片选
3	/RES	Rester 复位
4	A0	Data/Command control 选择指令或数据
5	/WR	Write (/WR) control signal input. 写
6	/RD	Read (/RD) control signal input. 读
4~14	D0---D7	8bit Date bus 数据
15	VDD	Power supply voltage (Positive) 电源 3~3.3V
16	VSS	Negative power supply,0V 地
17	VOOUT	positive voltage supply pin of the chip. 升压输出, 对地接电容
18~22	CAP3P, CAP1N, CAP1P, CAP2P, CAP2N	When internal DC-DC voltage converter is used, external capacitor is connected between these pins. 升压电路接电容
23~27	V1,V2,V3,V4,V0	LCD driving voltages. 分压电路
28	C86	MPU interface selection pin 选择8080或6800时序
29	P/S	Parallel data input/serial data input switch terminal 选择并口或串口
30	NC	空脚

LED 背光引脚

A	LED 正极, 供电电压+3.0V, 工作电流 30mA~45mA, 如用 IO 口控制, 需加三极管开关放大电路。
K	LED 负极, 0V, 或接 VSS。

5. Absolute Maximum Ratings/限定参数

Items	Symbol	MIN.	MAX.	Unit	Condition
Supply Voltage/供电电压	VDD	-0.3	+3.0	V	Vss = 0V
	Vlcd	-0.3	+9.0	V	Vss = 0V
Input Voltage/输入电压	VIN	-0.3	VDD+0.3	V	Vss = 0V
LED forward current/背光电流	If	0	30	mA	---
Operating Temp./工作温度	TOP	-20	+70	°C	---
Storage Temp./储存温度	Tst	-30	+80	°C	---

6. Electrical Characteristics/电气特性

6.1 Typical Electrical Characteristics

(V_{SS} = 0V, V_{DD} = 3.3V ± 10%, T_{op} = 25°C)

Items	Symbol	MIN.	TYP.	MAX.	Unit	Condition Pin
Operating Voltage/工作电压	V _{DD}	2.7	3.0	3.3	V	V _{DD}
LCD Operating Voltage	V _{op}	-	9.0	-	V	V ₀
Input High Voltage/输入高电压	V _{IH}	0.8 V _{DD}	-	V _{DD}	V	AO,W/R,RD, D0~D7
Input Low Voltage 输入低电压	V _{IL}	0	-	0.4 V _{DD}	V	
Output High Voltage 输出高电压	V _{OH}	0.7	-	V _{DD}	V	D0~D7
Output Low Voltage 输出低电压	V _{OL}	0	-	0.2	V	D0~D7
Supply Current/供电电流	I _{DD}	---	0.6	8	mA	V _{DD} ,V _{SS}

Note 1: There is tolerance in optimum LCD driving voltage during production and it will be within the specified range.

6.2. Timing Specifications

6.2.1. 8080 Mode System Bus Timing

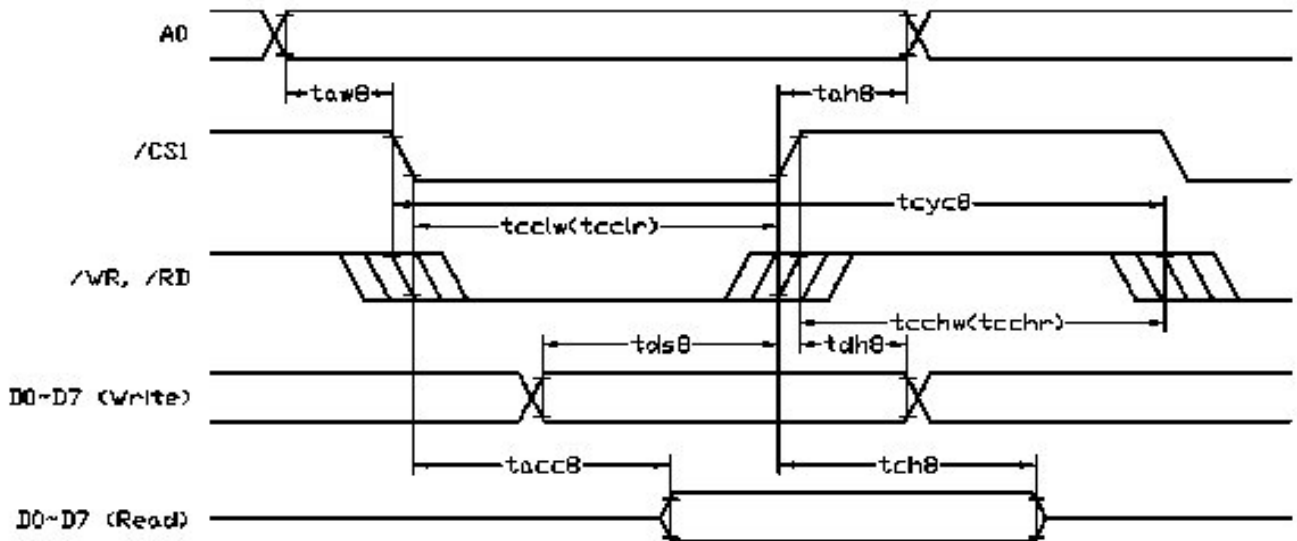

6.2.2. 6800 Mode System Bus Timing

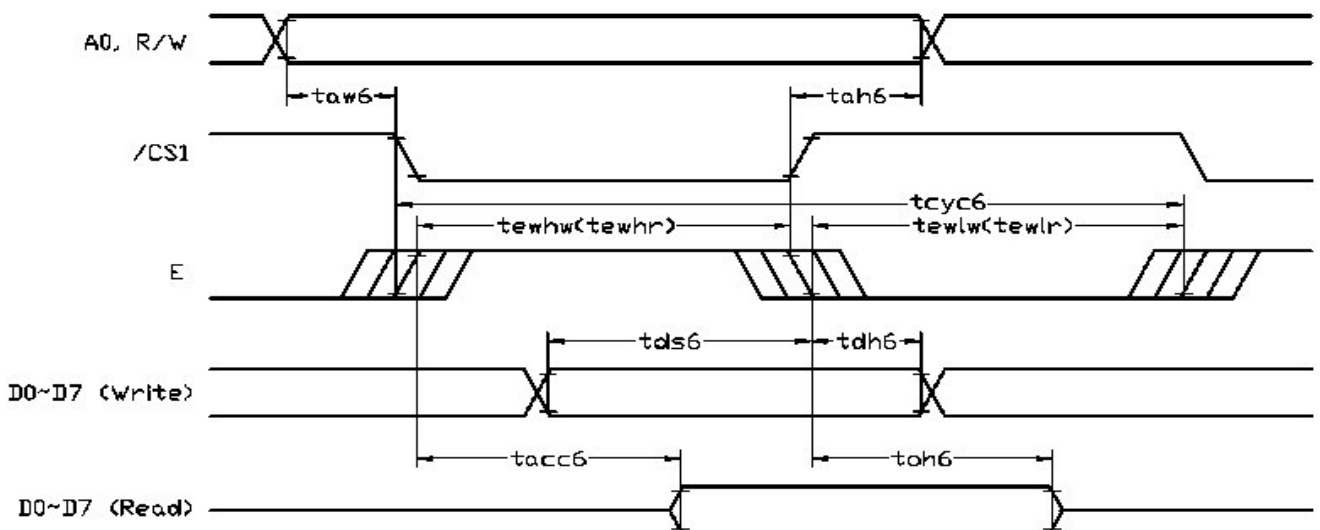

6.2.3

The 4-line SPI Interface

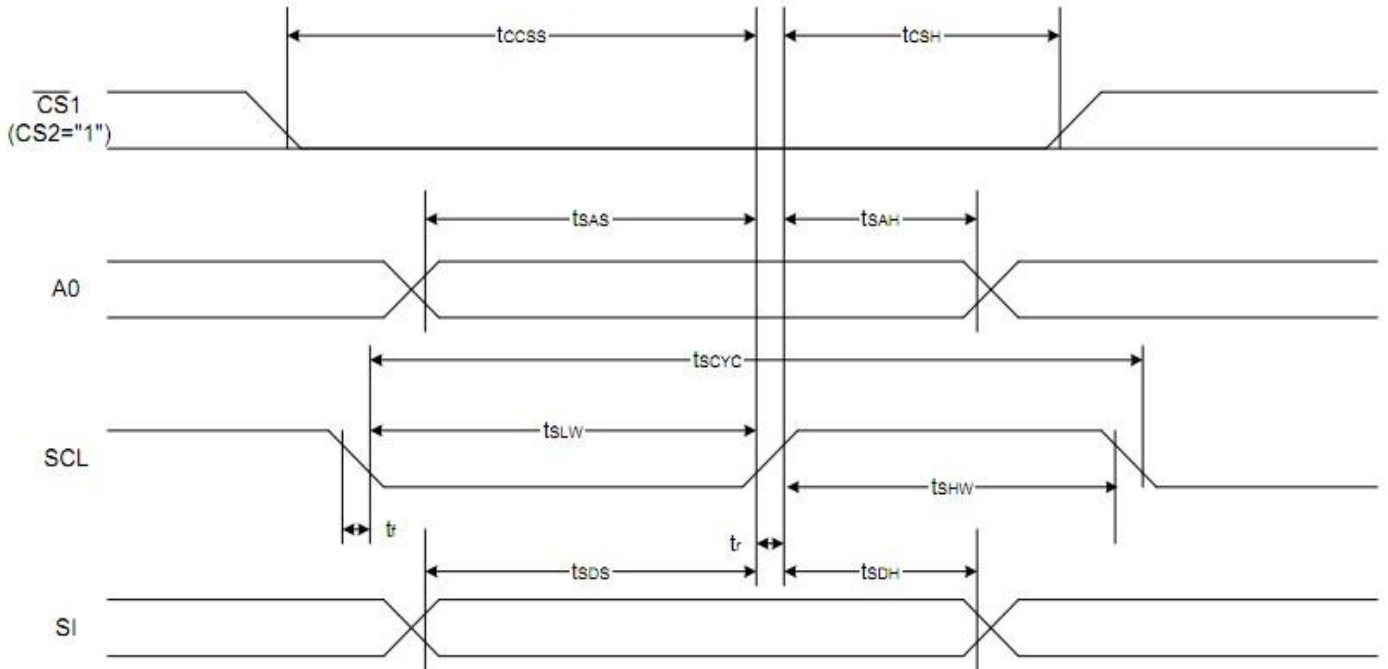

Item	Signal	Symbol	Condition	Rating		Units
				Min.	Max.	
4-line SPI Clock Period	SCL	T_{scyc}		100	—	ns
SCL "H" pulse width		T_{SHW}		50	—	
SCL "L" pulse width		T_{SLW}		50	—	
Address setup time	A0	T_{SAS}		30	—	
Address hold time		T_{SAH}		20	—	
Data setup time	SI	T_{SDS}		30	—	
Data hold time		T_{SDH}		20	—	
CS-SCL time	CS	T_{CSS}		30	—	
CS-SCL time		T_{CSH}		60	—	

6.2.4 Reset timing

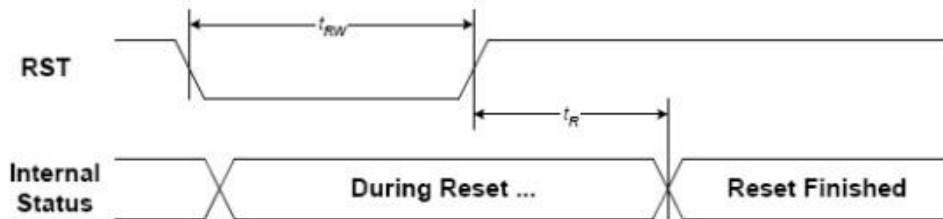

FIGURE 15: Reset Characteristics

($1.65V \leq V_{DD} < 3.3V$, $T_a = -30$ to $+85^\circ C$)

Symbol	Signal	Description	Condition	Min.	Max.	Units
t_{RW}	RST	Reset low pulse width		3	—	μS
t_R	RST,, Internal Status	Reset to Internal Status pulse delay		6	—	mS

7. Backlight Characteristics/背光特性

Items	Symbol	MIN.	TYP.	MAX.	Unit	Condition
Forward Voltage/电压	Vf	2.8	3.0	3.1	V	If=30mA
Reverse current/电流	Ir	---	30	40	mA	Vr=3V
Peak wave length/波长	λ	---	---	---	nM	If=25mA
Luminance/亮度	Lv	---	---	---	Cd/m ²	If=25mA
Color /颜色	White (白色, 或者其他色)					

8. Electrical-Optical Characteristics/光学特性

Items	Symbol	Condition	MIN.	TYP.	MAX.	Unit	NOTE
Response time/反应时间	Tr	Ta= 25°C	---	185	---	ms	2
	Tf		---	200	---		
Contrast ratio/对比度	Cr	Ta= 25°C	---	--	---		3
Viewing angle range/视角范围	θ	Cr \geq 2	-40	---	40	degree	

Note 1. Definition of response time

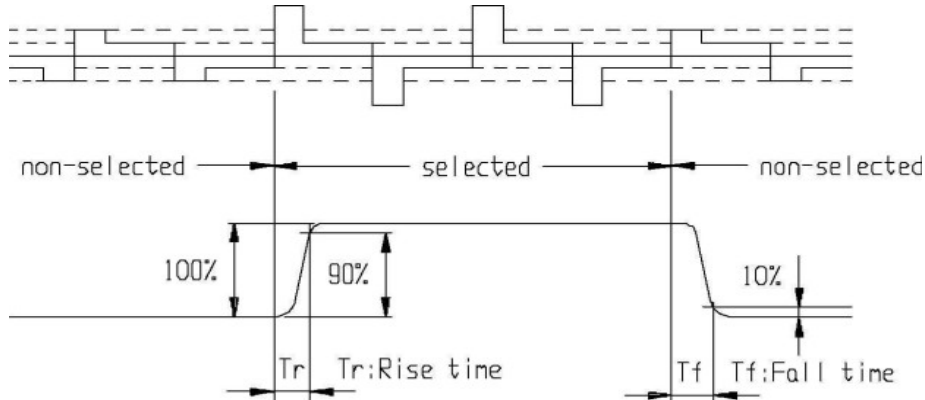

Note2 . Definition of Contrast Ratio 'Cr'

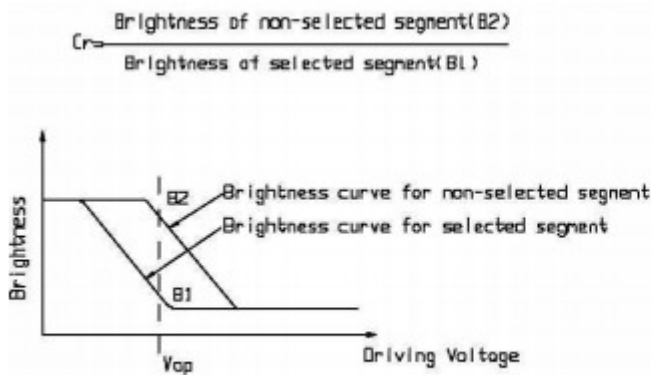

Note 3. Definition of Viewing Angle Range ' θ '

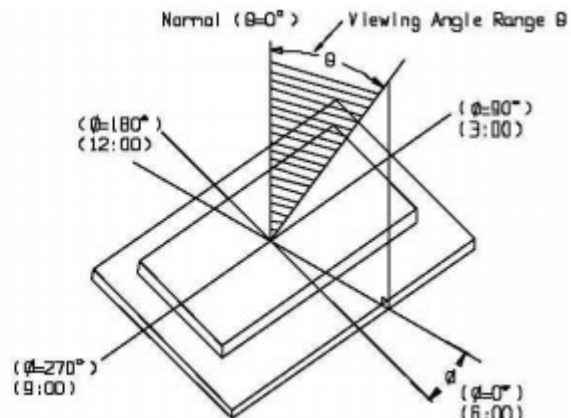

9. Control and display commands/指令描述

No.	Instrctions	Code												Function
		A0	/RD	/WR	D7	D6	D5	D4	D3	D2	D1	D0		
1	Display ON/OFF	0	1	0	1	0	1	0	1	1	1	1	DON	DON=0,display off DON=1,display on
2	Display start line set	0	1	0	0	1	Display start address						Set the display RAM display start line address	
3	Set Page Address	0	1	0	1	0	1	1	Page address					Set the display RAM Page address
4	Ser Column Address (Upper-4 bits)	0	1	0	0	0	0	1	Col. Add					Set the upper-4-bit of column address counter
	Ser Column Address (Lower-4 bits)	0	1	0	0	0	0	0	Col. Add					Set the low-4-bit of column address counter
5	Read Staus	0	0	1	Status				0	0	0	0		Read the status data
6	Write Display Data	1	1	0	Write Data									Write data into the display RAM
7	Read Display Data	1	0	1	Read Data									Read data from the display RAM
8	ADC Select	0	1	0	1	0	1	0	0	0	0	0	ADC	Set the display RAM address SEG output Correspondence ADC = 0,Normal. ADC = 1,Reverse
9	Normal/Reverse Display	0	1	0	1	0	1	0	0	1	1	REV	REV = 0, Normal REV = 1, Reverse	
10	Entire Display ON/OFF	0	1	0	1	0	1	0	0	1	0	EON	EON = 0, Normal EON = 1, Entire display ON	
11	Set LCD Bias	0	1	0	1	0	1	0	0	0	1	BIAS	Bias = 0, 1/9 Bias Bias = 1, 1/7 Bias	
12	Set Read-Modify-Write	0	1	0	1	1	1	0	0	0	0	0		Enter the "Read-Modify-Write" mode
13	Reset Read-Modify-Write	0	1	0	1	1	1	0	1	1	1	0		Clear the "Read-Modify-Write" mode
14	Reset	0	1	0	1	1	1	0	0	0	1	0		Resets the LCD module
15	SHL S elect	0	1	0	1	1	0	0	SHL	*	*	*		Set the COM scanning direction SHL = 0, Normal SHL = 1, Flipped in y-direction * = don't care terms
16	Power Control Set	0	1	0	0	0	1	0	1	VC	VR	VF		Set the power circuit operation mode VF : LCD Supply Voltage Follower VR : LCD Supply Voltage Regulator VF : LCD Supply Voltage Converter (1 = ON, 0 = OFF)
17	Regulator Resistor Select	0	1	0	0	0	1	0	0	Ratio				Set the built-in resistor ratio (Rb/Ra)
18	Electronic volume mode set	0	1	0	1	0	0	0	0	0	0	1		Set reference voltage mode
	Electronic volume register set	0	1	0	*	*	Electronic Control value						Set reference voltage register	
19	Power Save		-	-	-	-	-	-	-	-	-	-		Compound instruction Display OFF + Entire Display ON
20	NOP	0	1	0	1	1	1	0	0	0	1	1		Non-operation command

12. Inspection Standards/检验标准

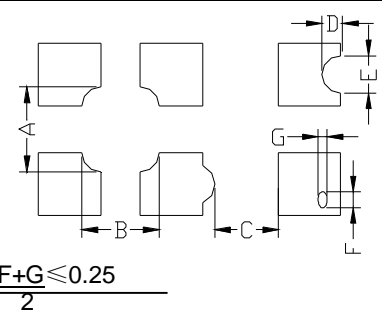
Item	Criterion for defects	Defect type
1) Display on inspection/显示效果	(1) Non display (2) Vertical line is deficient (3) Horizontal line is deficient (4) Cross line is deficient	Major
2) Black / White spot/黑点或白点	Size Φ (mm) Acceptable number $\Phi \leq 0.3$ Ignore (note) $0.3 < \Phi \leq 0.45$ 3 $0.45 < \Phi \leq 0.6$ 1 $0.6 < \Phi$ 0	Minor
3) Black / White line/黑线或白线	Length (mm) Width (mm) Acceptable number $L \leq 10$ $W \leq 0.03$ Ignore $5.0 \leq L \leq 10$ $0.03 < W \leq 0.04$ 3 $5.0 \leq L \leq 10$ $0.04 < W \leq 0.05$ 2 $1.0 \leq L \leq 10$ $0.05 < W \leq 0.06$ 2 $1.0 \leq L \leq 10$ $0.06 < W \leq 0.08$ 1 $L \leq 10$ $0.08 < W$ follows 2) point defect Defects separate with each other at an interval of more than 20mm	Minor
4) Display pattern/显示模式	 <p style="text-align: center;"> $\frac{A+B \leq 0.28}{2}$ $0 < C$ $\frac{D+E \leq 0.25}{2}$ $\frac{F+G \leq 0.25}{2}$ </p> <p>Note: 1) Up to 3 damages acceptable 2) Not allowed if there are two or more pinholes every three-fourth inch.</p>	Minor
5) Spot-like contrast irregularity/均匀度	Size Φ (mm) Acceptable Number $\Phi \leq 0.7$ Ignore (note) $0.7 < \Phi \leq 1.0$ 3 $1.0 < \Phi \leq 1.5$ 1 $1.5 < \Phi$ 0 Note: 1) Conformed to limit samples. 2) Intervals of defects are more than 30mm.	Minor
6) Bubbles in polarizer/玻璃内有气泡	Size Φ (mm) Acceptable Number $\Phi \leq 0.4$ Ignore (note) $0.4 < \Phi \leq 0.65$ 2 $0.65 < \Phi \leq 1.2$ 1 $1.2 < \Phi$ 0	Minor
7) Scratches and dent on the polarizer/玻璃刮痕/凹痕	Scratches and dent on the polarizer shall be in the accordance with "2) Black/white spot", and "3) Black/White line".	Minor
8) Stains on the surface of LCD panel/玻璃上有污点	Stains which cannot be removed even when wiped lightly with a soft cloth or similar cleaning.	Minor
9) Rainbow color/杂色	No rainbow color is allowed in the optimum contrast on state within the active area.	Minor
10) Viewing-area encroachment/玻璃边线出现在视域	Polarizer edge or line is visible in the opening viewing area due to polarizer shortness or sealing line.	Minor
11) Bezel appearance/铁筐外观	Rust and deep damages that are visible in the bezel are rejected.	Minor
12) Defect of land surface 表面缺陷	Evident crevices that are visible are rejected.	Minor
13) Parts mounting/部件安装	(1) Failure to mount parts (2) Parts not in the specifications are mounted (3) For example: Polarity is reversed, HSC or TCP falls off.	Minor
14) Part alignment/部件结合度	(1) LSI, IC lead width is more than 50% beyond pad outline. (2) More than 50% of LSI, IC leads is off the pad outline.	Minor
15) Conductive foreign matter (solder ball, solder hips)/杂质 (焊接遗留物)	(1) $0.45 < \Phi$, $N \geq 1$ (2) $0.3 < \Phi \leq 0.45$, $N \geq 1$, Φ : Average diameter of solder ball (unit: mm) (3) $0.5 < L$, $N \geq 1$, L: Average length of solder chip (unit: mm)	Minor
16) Bezel flaw/铁筐破裂	Bezel claw missing or not bent	Minor
17) Indication on name plate (sampling indication label)/标志	(1) Failure to stamp or label error, or not legible.(all acceptable if legible) (2) The separation is more than 1/3 for indication discoloration, in which the characters can be checked.	Minor

12. Handling precautions 注意事项

1. Refrain from strong mechanical shock and forces to the module. It may cause improper operating or damage to the module.
防止震动和压迫模组，以免造成模组损坏和运行正常。
2. The polarizer used on the display surface is easily scratched and damaged. Extreme care should be taken when handling. When cleaning the display surface, use soft cloth with a solvent recommended : ethyl alcohol , isopropyl or hexane) and wipe gently, do not use the following solvents : water, ketone or aromatics .
模组表面的偏光极易被刮伤和损坏，所以操作是要非常小心。请用蘸有乙醇，丙酮等溶剂的湿软布轻轻擦拭，不要使用水，乙酮等溶剂。
3. Wipe off water or oil drop immediately If you leave drop for a long time, stain and discoloration may occur.
要立即擦拭掉屏幕上的油滴和水滴，否则会出现污点和杂质。
4. Do not touch pads or pins of interface directly with bare hands. When handling the LCD module, put on a soft glover like finger-glover.
不要直接用手去触碰接口处的金属管脚。当操作模组的时候，请配带软指套。
5. Protect the module from static electricity, it may cause damage to CMOS LSI.
模组需要有防静电保护，否则会损坏CMOS LSI。
6. To prevent LCD panels from degradation, do not operate or store them exposed directly to sunlight or high temperature/humidity.
不要直接在太阳,高温或潮湿环境下操作和储存LCD模组，以免影响模组的质量。
7. If the liquid crystal leaks from the panel it should be kept away from the eyes and mouths. In case of contact with skins, wash away thoroughly with soap and water.
若有液晶漏出，务必避免其入眼入口。若沾到皮肤上了，马上用肥皂和水冲洗干净。
8. Soldering should be only performed on the I/O terminals within the temperature of $280 \pm 20^{\circ}\text{C}$ and soldering time should be less than 4 seconds.
要在 $280 \pm 20^{\circ}\text{C}$ 的条件下在I/O终端实现焊接，并且保证焊接时间短于4秒。
9. Supply voltage within the specified voltage limit, the maximum rating, higher voltage cause the shorter LCD life or damaged.
绝对要在指定的电压范围内驱动模组， 因为如果在高于指定电压的情况下驱动模组，会使模组寿命变短
10. Do not input any signals before power is turned on. Do not connect or disconnect the module on the state of Power-ON.
供电之前不要输入任何信号，不要在通电时连接和段开 LCD 模组。